

**Compact.
Versatile.
Flexible.**

HE HOMAG

CENTATEQ T-300

CNC processing center with tandem table

YOUR SOLUTION

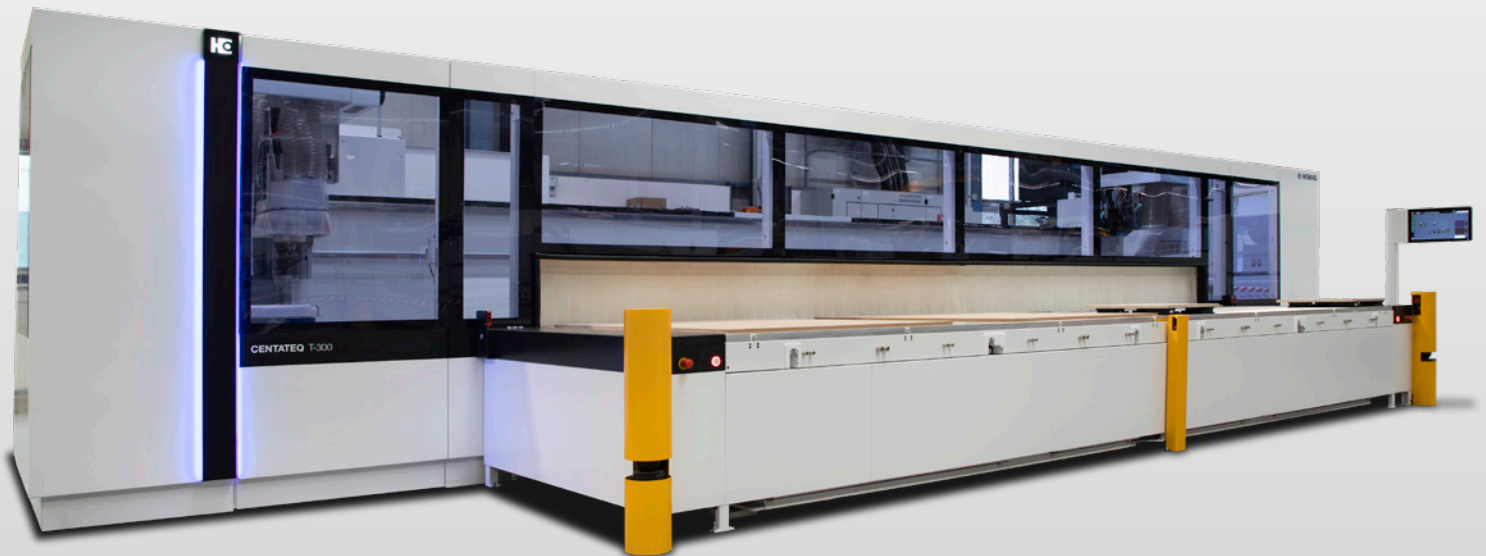





CENTATEQ T-300

When you decide on a HOMAG machine, you receive a powerful processing center for a wide range of tasks. This makes the processing center is a complete system that guarantees maximum performance and efficiency in individual production tasks at all times.

YOUR SOLUTION

CONTENT

- 04 Basic principle
- 08 Operating modes
- 09 Table guide
- 10 Safety concept
- 11 Comfort operation
- 12 Standard features
- 13 Drilling gear
- 14 Trimming spindles
- 16 Aggregates
- 18 Grid table
- 20 Overview of options
- 22 powerTouch2
- 24 Software
- 25 Technical data
- 26 tapio
- 27 HOMAG Life Cycle Services

The highlights at a glance | CENTATEQ T-300

WITH A VECTOR SPEED OF 141 M/MIN: THE FASTEST IN ITS CLASS



- 1 COMPACT**
Designed to maximize the processing area with minimum space requirements:
- Working area: 6,400 x 1,550 mm, per table: 3,150 x 1,550 mm
 - Surface area: 64 m²

- 2 VERSATILE**
Complete processing of workpieces over the entire working area:
- Premium-quality HOMAG 3-, 4-, or 5-axis technology
 - Fully equipped drilling gear with patented quick-change system

- 3 FLEXIBLE**
The right operating mode for every job:
- Synchronous: high output with identical workpieces
 - Independent: customized production and diversity
 - Combined: for particularly long raw materials

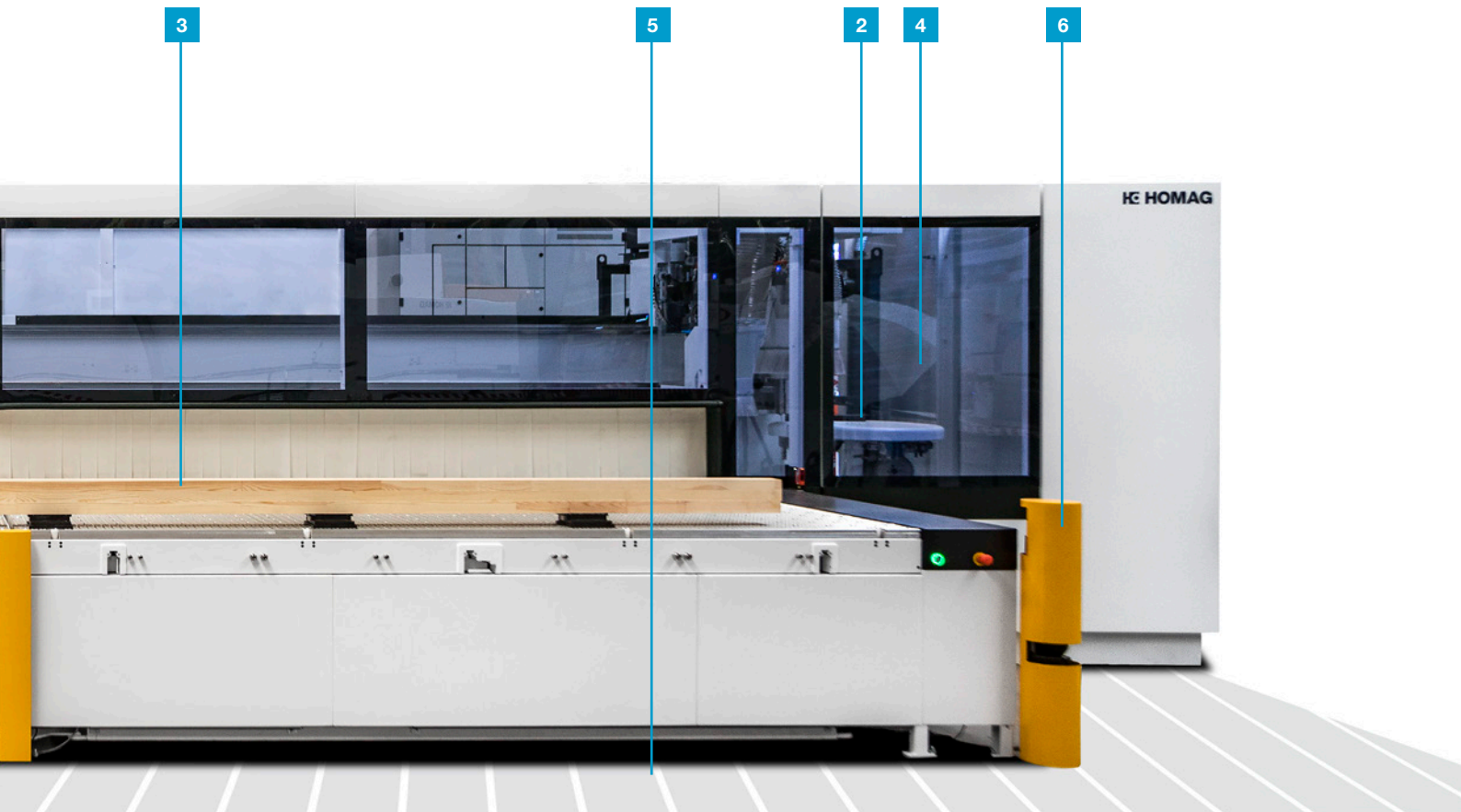

- 4 SPACE TO WORK**
The main elements are integrated in the machine – this not only increases efficiency but also provides more space to work
- No disruptive elements in the area
 - Barrier-free access to the 28 tool change slots

- 5 COMFORTABLE**
Literally machine-oriented handling
- Program start and stop function integrated on the machine frame
 - Stops and vacuum controlled via a foot switch on the machine
 - Tool is changed directly on the changer

- 6 MODERN**
The latest safety technology and user interface are used.
- safeScan safety technology
 - powerTouch2 user interface

Basic principle | Nesting

In one work step on a CNC processing center, workpieces are cut out of unprocessed panels and all the required vertical bore holes and grooves are made. To ensure that the raw material is cut so as to minimize wastage, the

programmed workpieces are nested automatically using optimization software. The CENTATEQ T-300 consists of two processing tables designed for nesting processing and other tasks.





The CENTATEQ T-300 processing center is particularly suitable for dividing panels by using the Nesting method and the complex processing of panel-shaped materials.

Operating modes |

The right solution for your requirements

To enable versatile and efficient processing, the machine operator can choose from three operating modes: synchronous, independent, and combined.

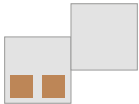

OPERATING MODE: SYNCHRONOUS

Two identical processing programs are processed synchronously on one table with two processing units.



Your solution for high quantities with an identical parts range.

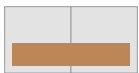

OPERATING MODE: COMBINED

One processing program is processed on both tables together.



Your solution for particularly long raw materials of up to 6,400 mm.

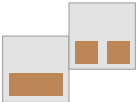

OPERATING MODE: INDEPENDENT

Two different processing programs are processed, one on each table respectively.



Your solution for a versatile product range with high performance requirements.

Table execution | In this series too, HOMAG focuses on quality and precision

Three guide rails for each table guarantee precise processing within the tolerance range.

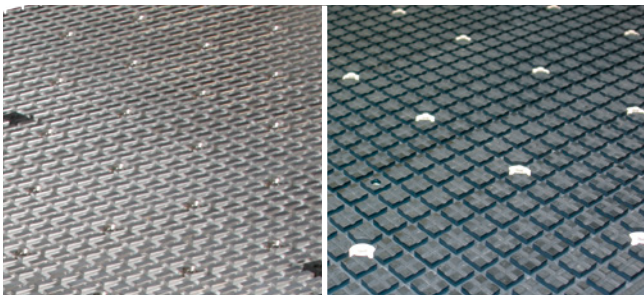
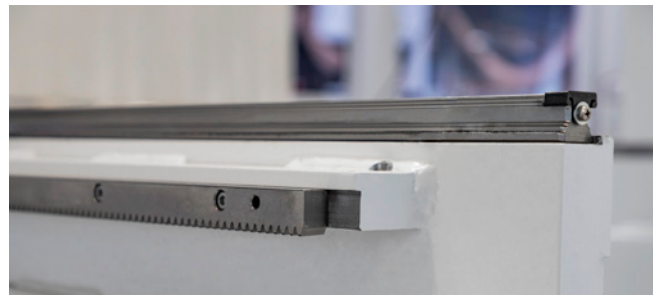
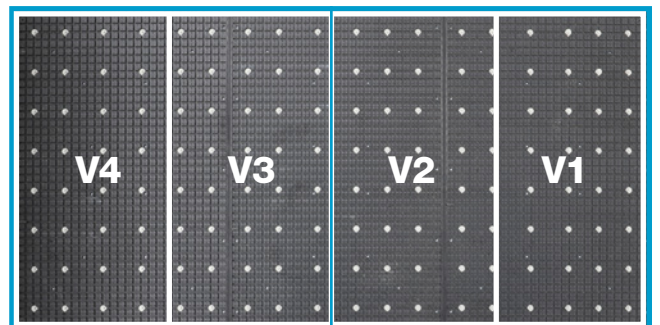
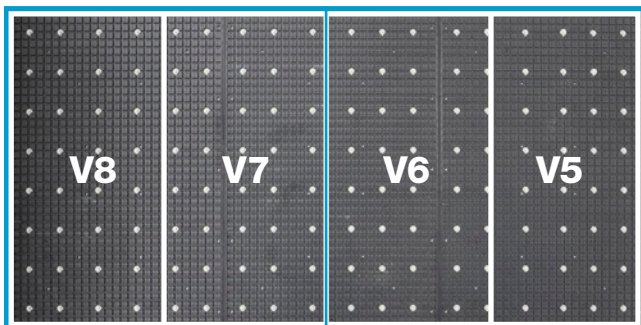

Table design both in aluminum and HPL (High Pressure Laminate).



Three guide rails for each table guarantee precise processing within the tolerance range



A total of eight vacuum zones and four processing fields

Safety concept | The right solution for everyone

The safety concept can be selected based on your individual requirement and budget.

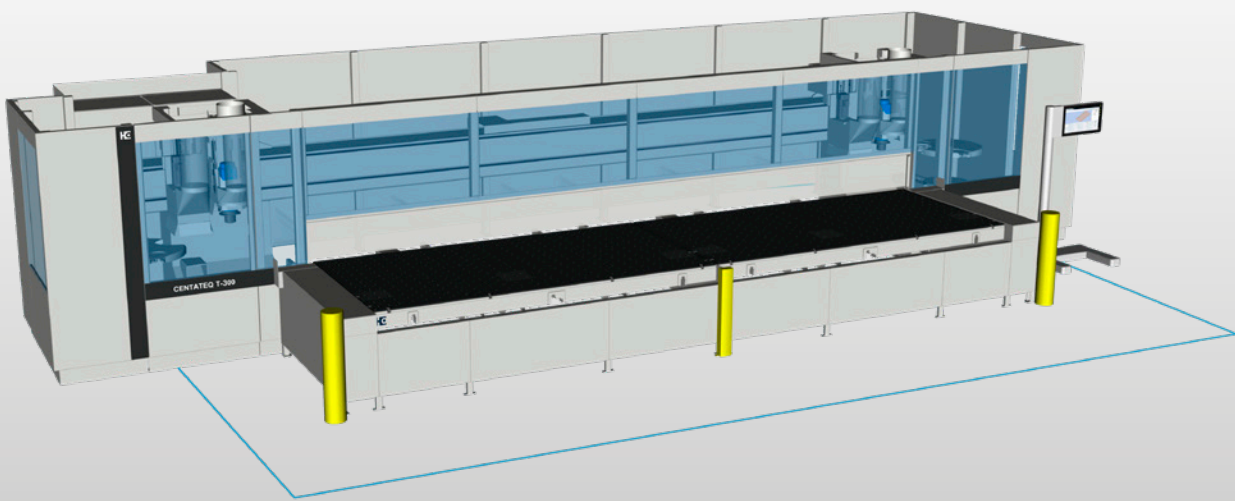

safeScan:

Scans the area around the movable table. If there is anyone in this zone, the speed is adjusted.

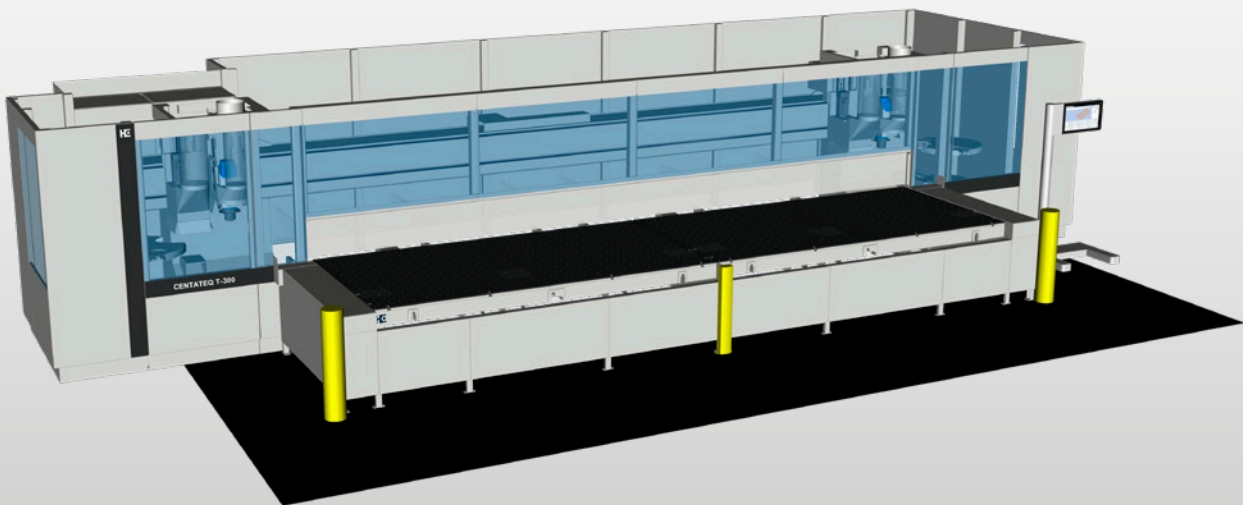

Safety mat:

If there is anyone on the safety mat, the speed of the movable table is adjusted.

Comfort operation |

Literally machine-oriented handling



Program start on the machine

- 2 Start buttons on the left and right



Foot switching strip

- Raise and lower stops
- Activate and deactivate the vacuum



Tool change directly on the machine

Standard features | Standards



Tool change system

Everything is in good hands and quick to access. Tool changers are the basis for flexible utilization of tools and units, and also for large saw blades or heavy units. You receive up to 28 (2*14) tool change slots.



Operator terminal

- 1 movable operator terminal as standard
- 2. Optional operator terminal



Alignment system with stop pins

16 Stop pins enable workpieces to be positioned optimally.

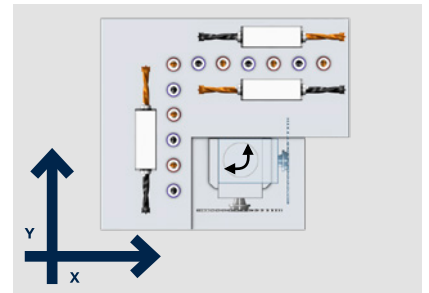

Drilling gear V12/H4X2Y

- 18 drilling spindles [High-Speed 7500]
- 12 vertical drilling spindles
- 4 horizontal drilling spindles in X
- 2 horizontal drilling spindles in Y
- Groove saw Ø 125 mm (0°/90°)



Closed energy chains

in the Y and Z direction to protect cables and hoses.

Drilling gear |

Exact drilling depth with HOMAG drilling gears

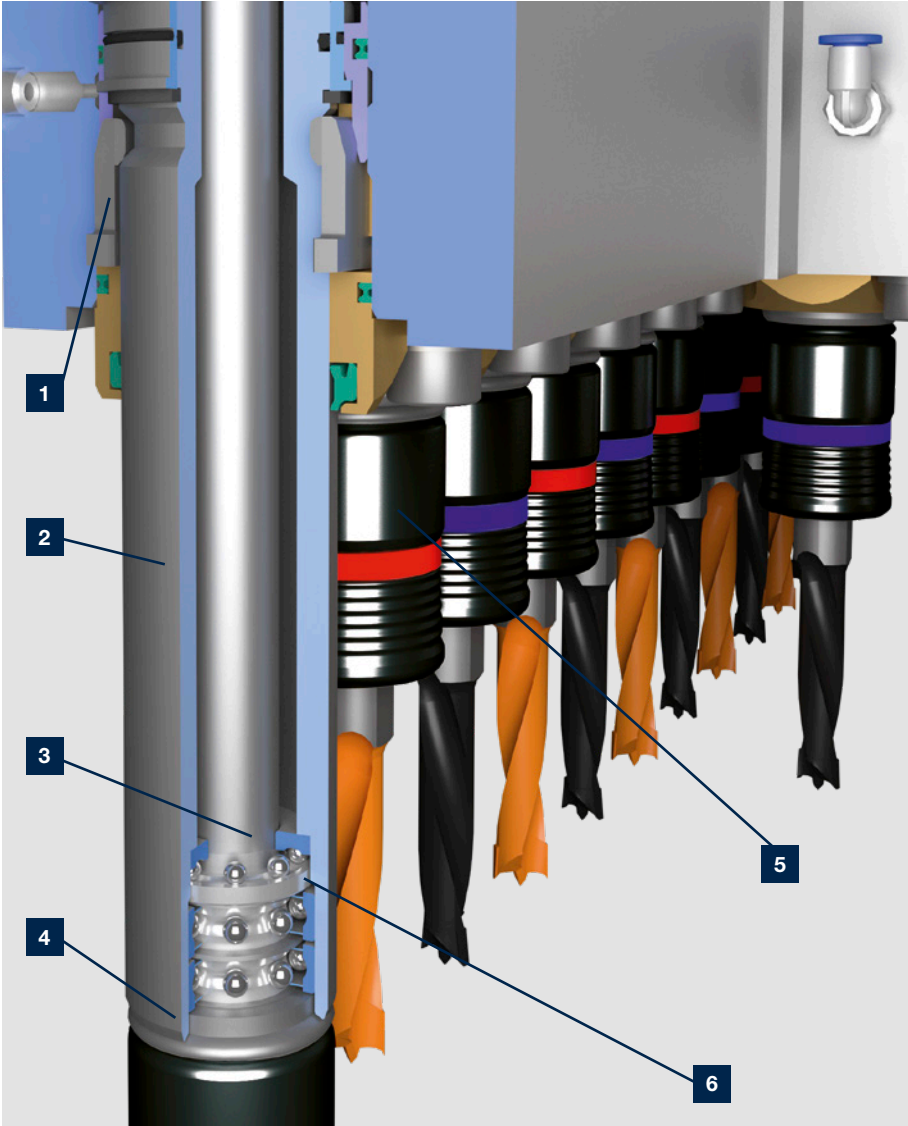

- 1** Spindle lock for accurate drilling depth
- 2** Dual-effect cylinder: pneumatic spindle advance and return stroke
- 3** Large diameter of the sleeve and short and constant distance of the drill bit to the bearing for high lateral stability and high precision
- 4** Vertical sleeve: The vertical drill sleeve is installed, the drilling spindle is housed in the sleeve
- 5** Quick-change system for toolfree drill change
- 6** Separate axial bearing to absorb the direct drilling forces



Patented quick-change system for a drill change without tools to reduce setup times.

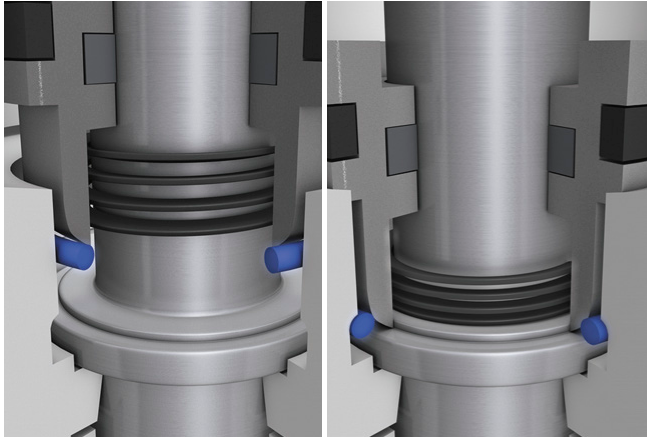

Automatic spindle lock — patented system for a drilling depth that is always accurate for numerous different materials. With speeds from 1,500–7,500 rpm for high feed speeds or short drill cycles.

Spindle technology | Something for everyone

Connections to the future — our interfaces contain patented technologies that expand the range of tasks your system can perform. This opens up unlimited production possibilities to

you. Sawing, drilling, routing, or trimming with spindles — the choice is yours.

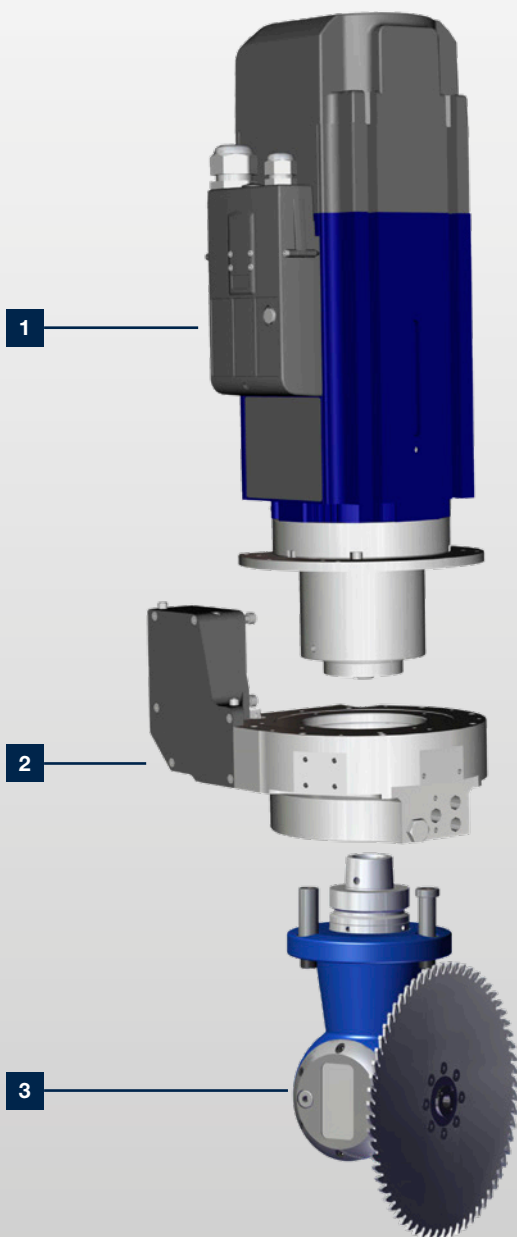

- 1** Air-cooled spindle:
High-performance, robust,
and proven trimming spindles
with an air cooling with 10 kW
(13.2 optional) trimming power
- 2** C axis:
Interpolating C axis with three-
point pneumatic interface for
units
- 3** FLEX5 unit



DRIVE5CS

The smart DRIVE5CS 5-axis head — more compact with short force paths. A lot of technology in a small space with no processing limitations. Liquid-cooled spindles with 10 kW (optional 12 kW trimming power) for high-power work. The short design creates more space for processing (e.g. with a 350 mm saw blade).

Individual options | Aggregates

AGGREGATES FOR FLEXIBLE PROCESSING

The aggregate required for the respective processing step are inserted into the main spindle of the machines fully automatically from the tool change systems. They can be swiveled from 0° to 360° via the C axis, for example. You get considerable flexibility and consequently a great deal of freedom to implement your ideas. Always the optimum solution for your specific tasks.



Vertically traced trimming unit



High-performance planing*

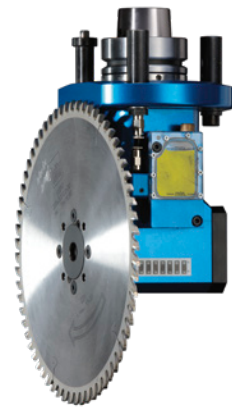

High-performance sawing*



Belt sanding unit



Eccentric sanding unit



FLEX5 drilling/sawing/trimming*



**Drilling/trimming/sawing*,
2 spindles**



**Drilling/trimming*,
4 spindles**



**Lock casing*,
2 spindles**



**Drilling/sawing, swiveling*,
(0°–90°)**



**Drilling/trimming, swiveling
crowned*, (0°–90°)**



Cutting unit*

* please see the respective technical data sheets for maximum tool lengths and diameters

The grid table |

For nesting and more



Vacuum clamp Vacuum clamping elements for insertion in the grooves of the grid table

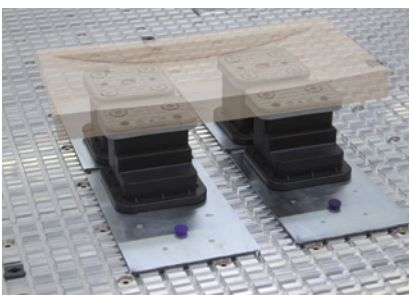
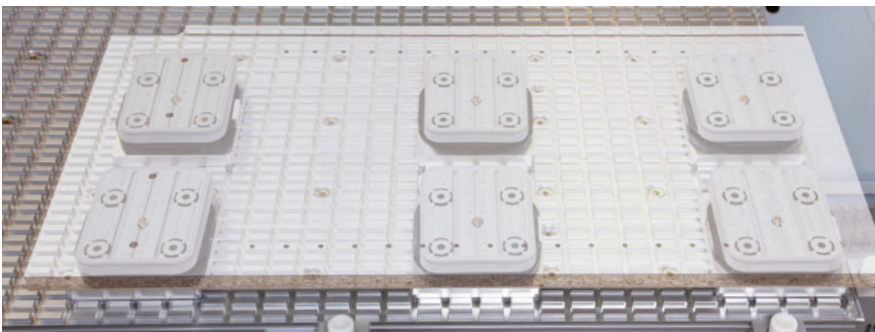
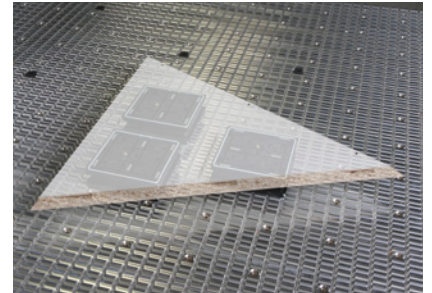

Maxi-Flex system System base plate for vacuum clamp that can be equipped as required

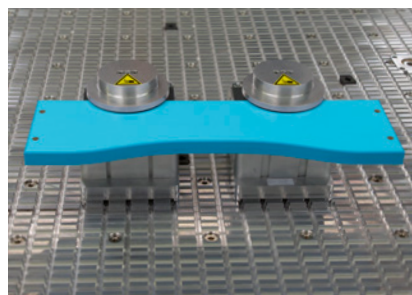

Multi-clamp Vacuum-actuated clamping elements for clamping strips and scantlings

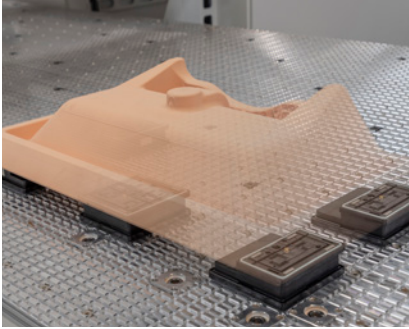

The wide range of vacuum suction units with different installation heights means that horizontal processing (e.g. for doors) can be carried out quickly and easily. It also means that, in some cases, clamping templates are not needed to process technical components and shaped parts.

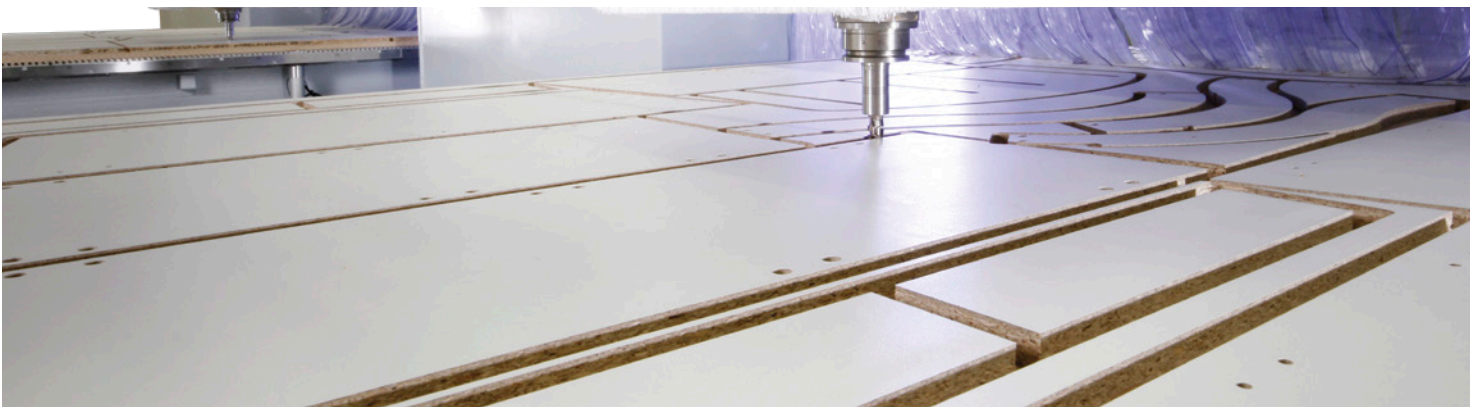
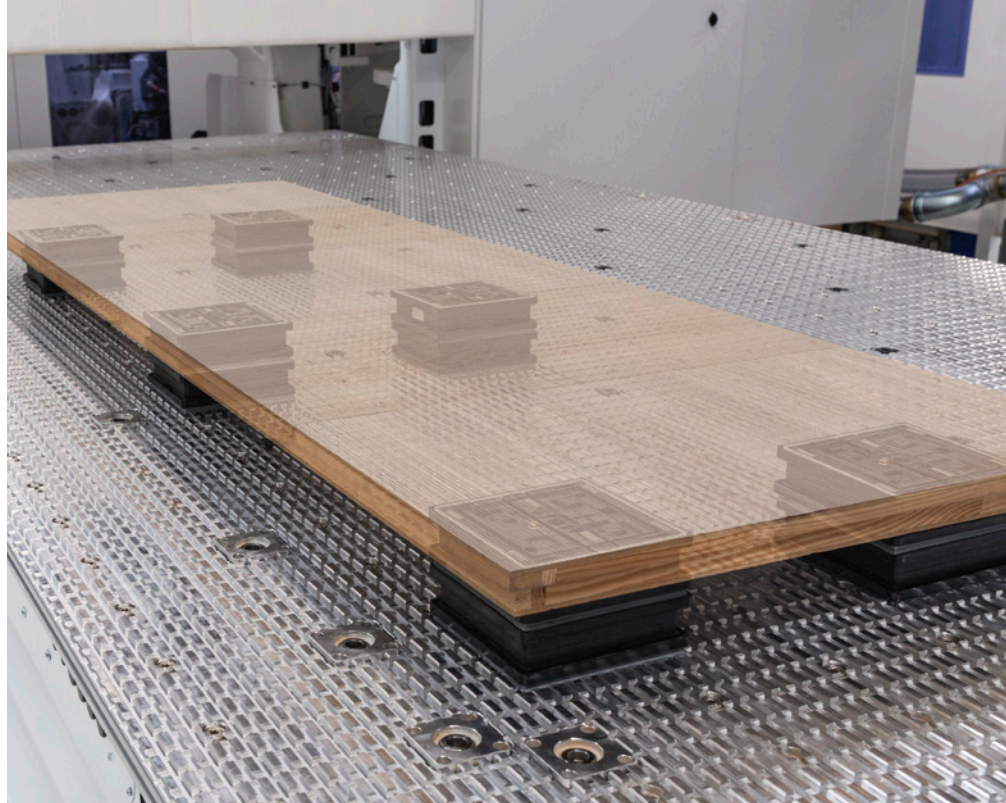

Nesting processing of panel materials: waste-optimized division and processing in the surface

Overview of options | CENTATEQ T-300

CENTATEQ T-300 OPTIONS MATRIX												
	ROUTING						DRILLING GEAR		TOOL CHANGER	TABLE DESIGN		
	10kW	13,2kW	C-axis	Flex5 interface	Vibration sensor	Unit interface	V12	V12H6N	Number of slots	ALU	HPL	Number of stop pins
3-axis		<input type="radio"/>			<input type="radio"/>							
4-axis		<input type="radio"/>	<input type="radio"/>	<input type="radio"/>	<input type="radio"/>	<input type="radio"/>	<input type="radio"/>	<input type="radio"/>	28 (2*14)	<input type="radio"/>	<input type="radio"/>	16
5-axis	<input type="radio"/>	<input type="radio"/>			<input type="radio"/>	<input type="radio"/>						

Default: Option:

* Max. trimming dimension, trimmer diameter 25 mm

** With right-hand processing slots

*** From table



MAX. PROCESSING DIMENSIONS IN MM(*)**)			OPERATING MODES			CONVENIENT OPERATION	SAFETY CONCEPT		SOFTWARE			AXES
X direction	Y direction	Z direction***	Combined	Independent	Synchronous		safeScan	Safety mat	tapio	CutRite	intelliDivide	
6,400	1,550	160	✓	✓	✓	✓	○	○	✓	○	○	
												DRIVE 5CS

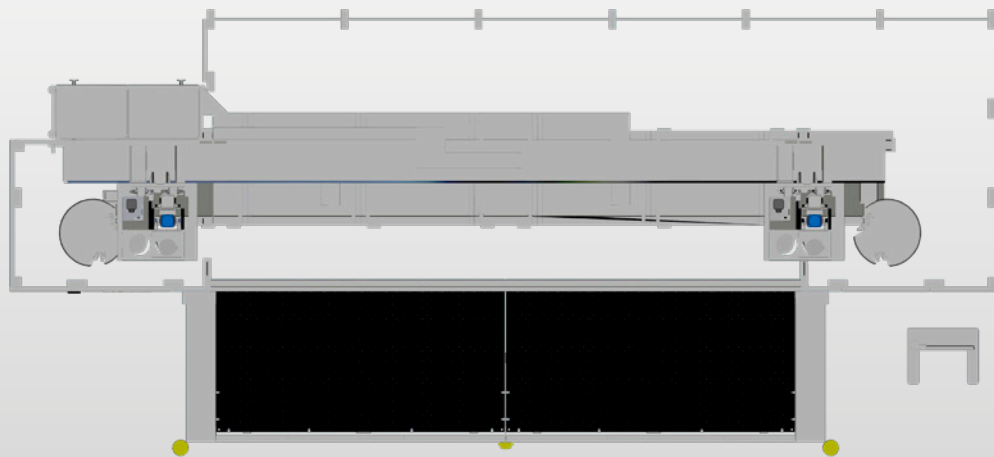

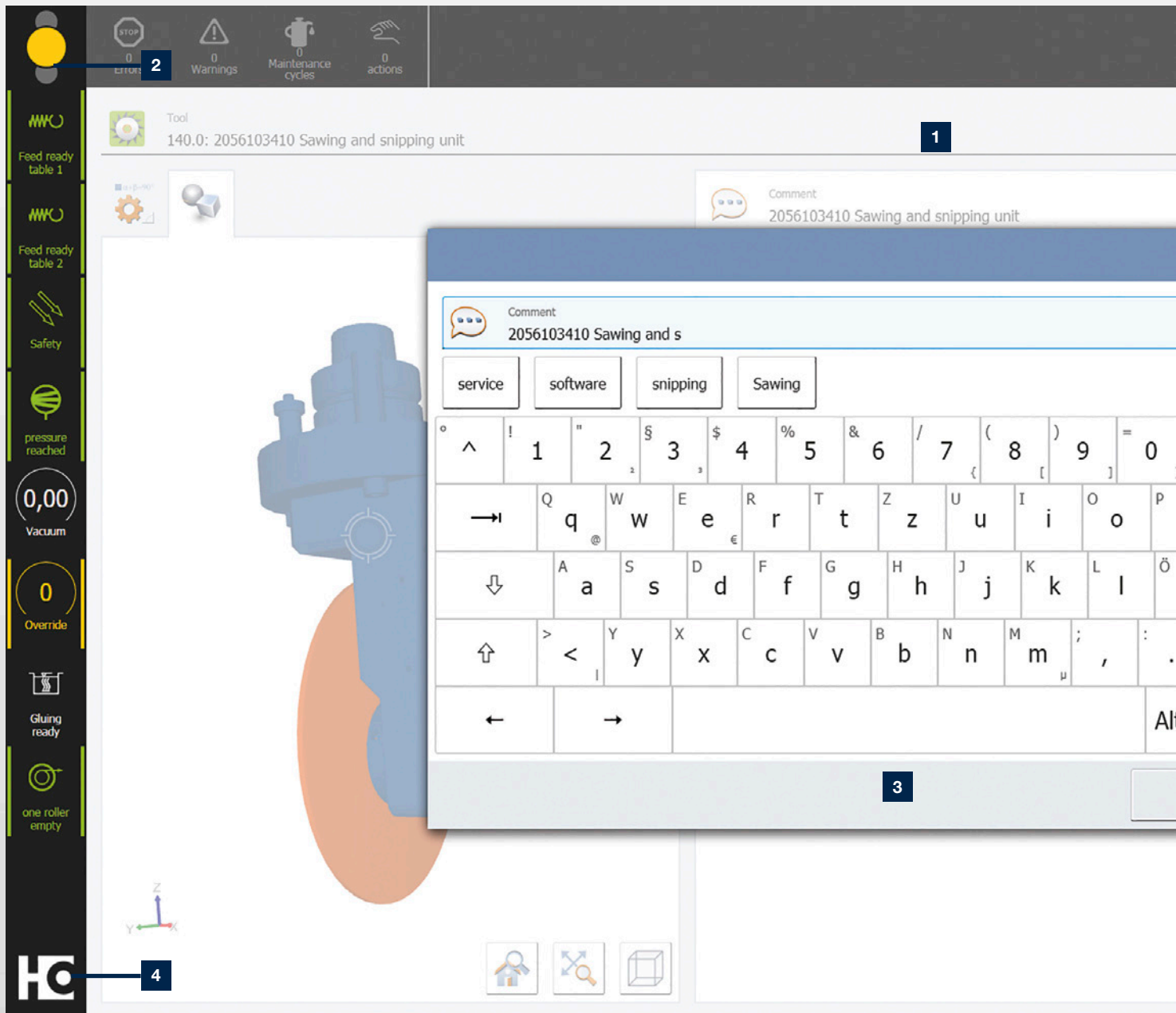

- 1 The powerTouch2 screen is clearly laid out and logically structured. You can see all the main information at a glance, but you still have all the details.
- 2 We have also improved the traffic light dialog again. You can now directly influence the machine's production readiness by selecting actions via the traffic light icon.
- 3 Functional pop-up keyboard that can be kept open, including auto-complete for faster input (when you enter the first few letters, frequently used applications are suggested and you can select them directly).
- 4 Enhanced "Start" menu that displays additional information (e.g. indicates how many messages there are, or has status bars that show how far the application has progressed) and allows actions to be called up directly (e.g. confirm actions without having to go to the application).

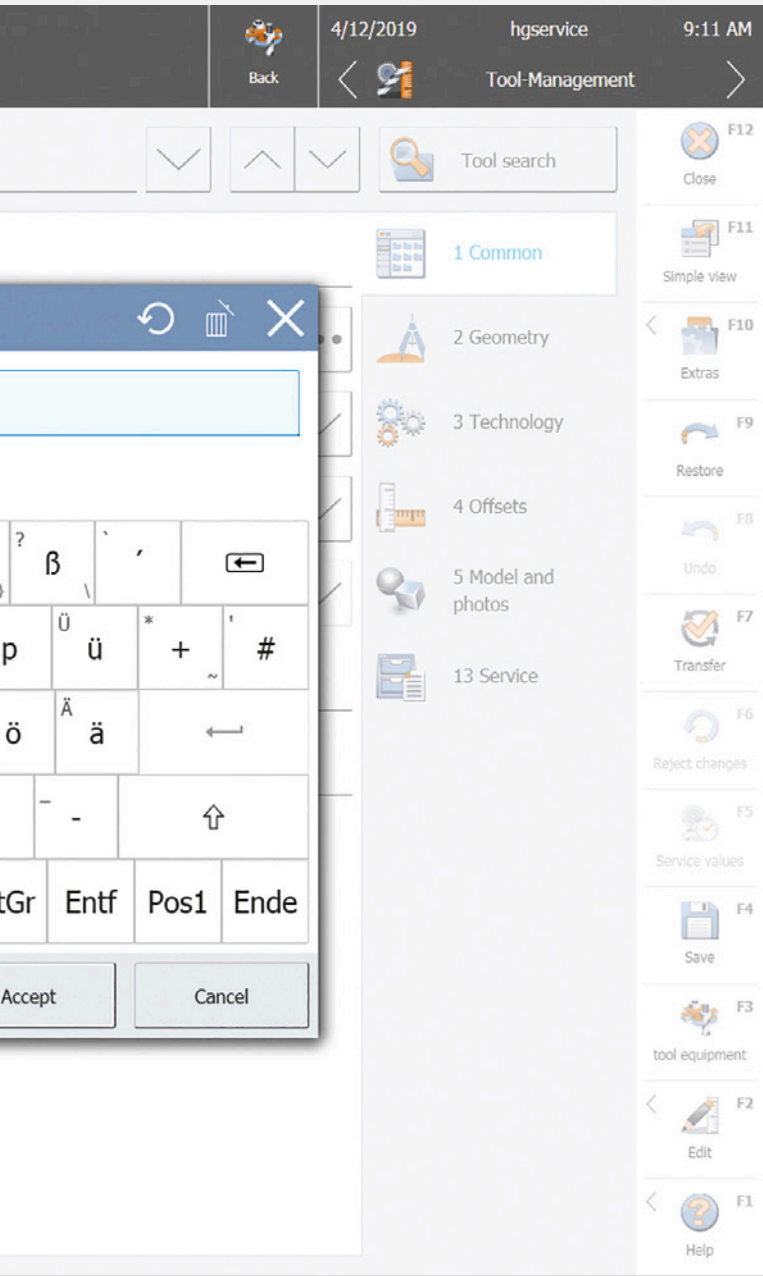

Next generation of powerTouch: powerTouch2

Faster, clearer, easier to use: reap the benefits of our powerTouch touch user interface, which has been developed further. We have optimized our standardized operating concept further and adapted it to the needs of our customers. You can now control your HOMAG machines more quickly and more intuitively. The new and contemporary design is clearly structured. The innovative touch operation is designed to enable you to get the desired result easily and comfortably.

With the new powerTouch generation, you can enter valves on the machine more quickly. This saves you up to 30% of time compared to the previous version. This is all possible thanks to new features, such as automatic word completion, a pop-up keyboard that can be kept open, and Windows-like functions such as the ability to select frequently used actions directly via the start button.

Our successful powerTouch philosophy — **simple, standardized, ergonomic, evolutionary** – consistently advanced

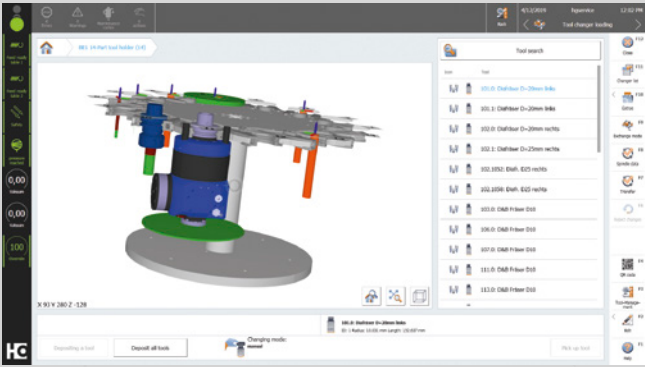

- OVERVIEW OF THE HIGHLIGHTS:**
- Direct and efficient operation, up to 30% faster
 - More informative and more transparent thanks to additional information and live preview images instead of program icons
 - New applications for operating and controlling machines and plants (e.g. NCCenter in a PC87 control system for CNC machines, or woodCommander 4 for throughfeed machines).
 - Fresh, attractive design based on the new HOMAG machine design

Software |

CENTATEQ T-300

HOMAG software and control modules ensure maximum flexibility and operational safety. A matter of course with HOMAG: Interfaces to external programming and design systems, auxiliary programs for nesting, and modules for machine monitoring and performance tracking.

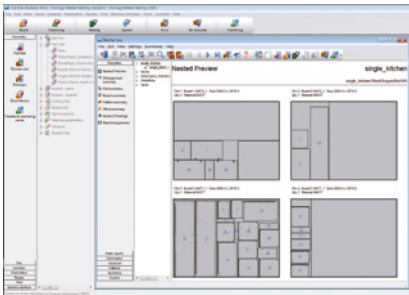

Cut Rite Nesting

- Optimization software: woodNest Basic and Cut Rite Nesting
- Optimization and generation of cutting plans for rectangular and free-formed workpieces (woodNest Basic: manual | Cut Rite Nesting: automatic)
- Cut Rite functions:
 - Import of parts lists, e.g. from Excel, or direct import of woodWOP programs
 - Additional milling strategies “bars”, “common line” and “stay down”
 - Includes material management, parts sorting by material type, and label printing in the office
 - Manual editing of cutting plans



powerTouch PC87 with full touch operation

- 3D view of the machine bed, consoles, suction unit and workpiece
- Simple assignment using drag & drop
- Saving and loading of complete assignment situations
- Automatic location-specific suction unit recommendation with selectable suction unit types
- Manual clamping equipment positioning using touch under consideration of all travel areas

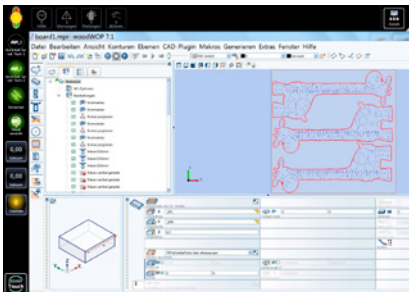

woodWOP – efficient thanks to fast programming

- Fast and intuitive operation thanks to simple, direct navigation
- Select from a choice of variables for flexible variable programming
- Quickly create individual subprograms
- Increased programming security through 3D images of workpieces, processing and clamping equipment.
- Very easy to use through infinitely adjustable windows, multi-screen capability, language-neutral input screens, help images, etc.
- The largest forum on CNC programming on the Internet: forum.homag.com

Technical data |

Installation area and technical data

WORKING DIMENSIONS

Max. workpiece dimensions	L x W x T	mm	6 400 x 1 550 x 260
----------------------------------	-----------	----	---------------------

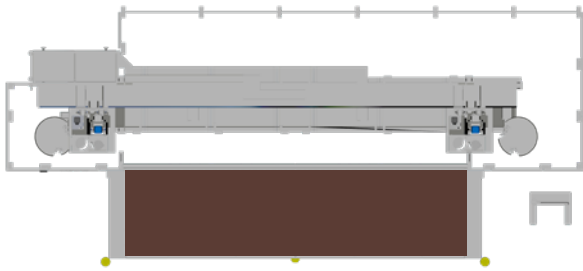

INSTALLATION DIMENSIONS

Assembly dimensions	L x W x H	mm	11 100 x 5 650 x 2 250
----------------------------	-----------	----	------------------------

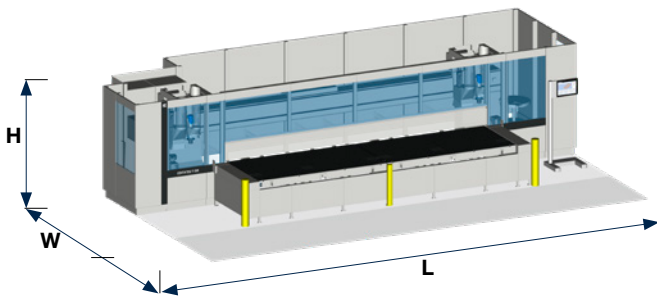

TECHNICAL DATA

Vector speed	m/min	(X-Y) 141 - (Z) 19
Compressed air	bar	7
Compressed air connection	Inches	R 3/4
Suction stubs	mm	2 x 250
Suction capacity	m ³ /h	2 x 4 950
Electrical connection value	kW	46

Apps that make working life easier.

tapio
Partner

DataSave

- Protects machine and configuration expertise
- Faster service for machine breakdowns
- Saves time when restarting production
- Saves on maintenance costs
- Automatic backups of several machines

ServiceBoard

- Create service cases quickly and easily and send them to the correct service partner
- Live video diagnostics to solve service cases with image support
- Video reduces the language and distance barriers
- Also works without a machine connection to tapio (and is therefore ideal for older machines)

MachineBoard

- Push notifications
- Machine data and status can be viewed from anywhere in real time
- Lists of errors, warnings, maintenance tasks and actions
- Displays the remaining time until the next intervention by the machine operator

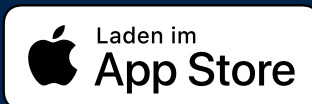

Free demo for all tapio apps, no registration required. Simply download and test.

tapio is the open wood industry ecosystem

This means that everyone involved in the wood industry can participate.
Because together with our business partners, we develop digital solutions for everyone.

Currently available in the EU and Switzerland.

(Due to the fast pace of the IT-landscape, the compatibility to the tapio platform is warranted for five years).



For you more than...

1,350

service employees worldwide

90 %

less on-site service thanks to
successful remote diagnosis

5,000

customer training sessions per / year

150,000

machines, all electronically documented
in 28 different languages – in eParts

HC LIFE CYCLE SERVICES

Optimal service and individual consultations are included in the purchase of our machines. We support you with service innovations and products which are especially tailored to your requirements. With short response times and fast

customer solutions we guarantee consistently high availability and economical production – over the entire life cycle of your machine.



REMOTE SERVICE

- Hotline support via remote diagnosis by our trained experts regarding control, mechanics and process technology. Thus, more than 90% less on-site service required and consequently a faster solution for you!
- The ServiceBoard App helps to solve tasks in a fast, simple and concrete way. This is achieved by mobile live video diagnosis, automatic sending of service requests or the online spare parts catalog eParts.



SPARE PARTS SERVICE

- High part availability and fast delivery.
- Ensuring quality by predefined spare parts and wear parts kits, comprising original spare parts.
- Identify and inquire for spare parts online under www.eParts.de 24/7, or buy even faster and more comfortably in the new HOMAG Webshop eCommerce.



FIELD SERVICE

- Increased machine availability and product quality by certified service staff.
- Regular checks through maintenance / inspection guarantee the highest quality of your products.
- We offer you the highest availability of technicians in order to reduce downtimes in case of unpredictable troubles.

HOMAG Group AG

info@homag.com

www.homag.com



YOUR SOLUTION