

Universal application.

HC WEINMANN

Our assembly tables

BUILDTEQ
MOVETEQ

YOUR SOLUTION







BUILDTEQ/MOVETEQ assembly tables — Versatile and future-proof

BUILDTEQ carpentry tables and MOVETEQ element tables enable you to easily produce highly accurate timber frame constructions. The tables are suitable for a wide range of applications, including wall, roof, floor and gable elements. A higher level of prefabrication and the consistently high quality increase production efficiency.

YOUR SOLUTION

MORE: [HOMAG.COM/WEINMANN](https://www.homag.com/weinmann)

CONTENT

- 06 Standard features of carpentry tables
- 08 BUILDTEQ A-300
- 10 BUILDTEQ A-500 / A-530
- 12 BUILDTEQ A-550 / A-570
- 14 Carpentry table options
- 16 Butterfly turning table
- 20 Element table series
- 22 BUILDTEQ F-500
- 24 MOVETEQ P-300
- 25 MOVETEQ P-500
- 26 MOVETEQ P-700
- 28 MOVETEQ W-100
- 29 Control technology
- 30 Machine layout and technical data
- 34 Service

Covering a wide range of house construction applications

WEINMANN assembly tables are suitable for all types of element and a wide range of tasks, meaning they can be used in a variety of ways. BUILDTEQ and MOVETEQ assembly tables are available in a number of different variations — so they can be used by carpentry businesses, or integrated into larger production lines.



Versatile expansion options

- An optional tilt function enables elements to be rotated and removed safely and gently
- Modular construction: The range includes solutions from self-build tables to tiltable carpentry tables. The tables can be integrated into both compact systems and larger production lines
- Special configuration options are available for heavy elements weighing up to 5 tons

Universal application scope

- Suitable for any element type (walls, rooves, floors, gables): flexible clamping bolts allow a change to a different element type in just a few seconds
- The availability of different models means that the tables can be used in timber frame construction as well as in the prefabricated house industry
- Two clamping circuits enable simultaneous manufacture of two elements on one assembly table

Safe and ergonomic

- Ergonomic processing height
- All control elements are installed directly on the table
- Safe work surface thanks to solid, non-slip sheathing

Carpentry tables for trade use

These tables are ideally suited for use in smaller and medium-sized carpentry businesses that want to produce high-quality wall, roof and ceiling elements easily and ergonomically. The tables can also be used to easily produce special elements for gables, bays and flap tiles.



Butterfly turning tables

This system, consisting of two assembly tables, enables elements to be turned safely and carefully. The automated turning operation makes it much easier to handle elements. Different variants are available to cater for the space available and the intended application.

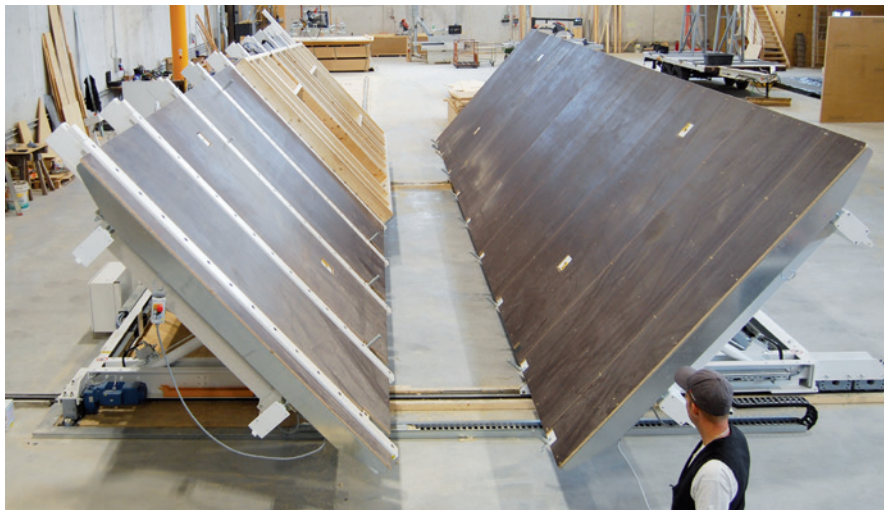

Element tables for industrial use

The element tables are ideal for integration into production lines and can take over a wide range of tasks. These tasks include turning elements, aligning elements at the correct angle for safe sheathing and processing with a CNC multifunction bridge, transporting elements in a longitudinal or transverse direction, and tilting the elements for storage.



BUILDTEQ carpentry tables — The universal tool

The BUILDTEQ series offers a wide variety of models for trade use. Regardless of whether a self-build table, an insert table, or a tilt table would best suit your requirements — a number of variants are available for you to choose from.

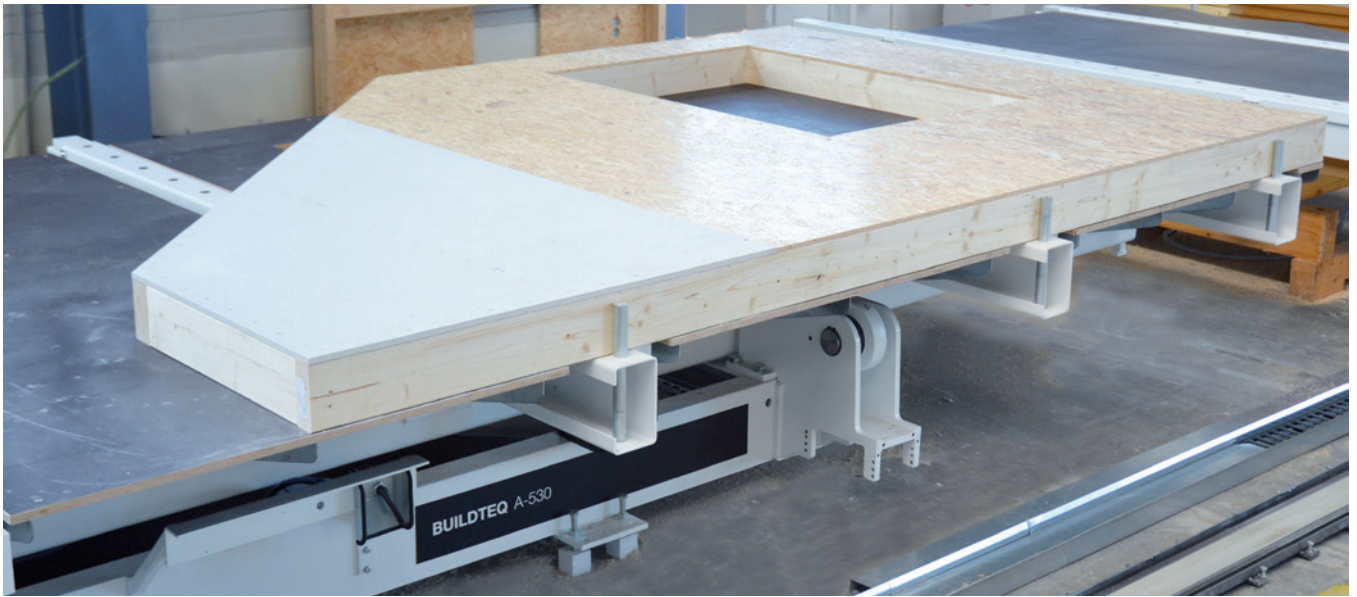

	BUILDTEQ A-300	BUILDTEQ A-500	BUILDTEQ A-530	BUILDTEQ A-550	BUILDTEQ A-570
	Self-build solution	Insert table for universal application	Hydraulic tilting	More options with hydraulic system and carriage	Individually configurable
Max. element length (m)	7 / 8 / 10 / 12	6 / 8 / 10 / 12		6 / 8 / 10 / 12	6 / 8 / 10 / 12
Element width (m) (extensions included in the standard features)	0.4 - 3.2 Extensions enable up to 3.8				
Hydraulic swivel device	-		✓		Optional
Full-surface sheathing	Self-assembly		✓		
Carriage	-		-	✓	Optional
Individually configurable					✓

Plenty of features, even in the basic version

Even with only the standard features installed, the BUILDTEQ assembly tables contain a number of helpful details that make day-to-day working life much easier. The stable design means that even heavy and complex elements can be processed. Tables equipped with the standard features can be used to manufacture elements weighing up to 3.5 tons.



C-PowerTec clamping beams

Automated frame work clamping means that elements can be manufactured with more ease and at greater speed.

- Reduced manufacturing times: the plate and beam are clamped without any gaps and can be joined immediately using nails
- Variety of elements: pneumatic clamping beams with extensions allow production of elements up to 3.8 m wide, for use in commercial construction, for example
- High level of quality: a precise horizontal position is guaranteed, even at full extension



Two clamping circuits

Enables simultaneous manufacture of two elements on one work table.

- Separate clamping circuits mean that two elements can be clamped
- Available for all assembly tables from a length of 10 m



X stop with stop pin

Elements can be aligned at the correct angle at the X stop.

- Precise assembly at the construction site thanks to exact alignment at an angle of 90°
- Zinc-plated 60-mm stop pin
- Various pin positions can be achieved thanks to a stop holding fixture with seating holes



Solid, non-slip sheathing

Provides a high level of work safety thanks to a non-slip surface.

- Sheathing made from water-resistant glued phenolic plywood
- Included as standard for the BUILDTEQ tables, with the exception of the BUILDTEQ A-300

The BUILDTEQ A-300 self-build table — the flat-pack solution

The BUILDTEQ A-300 self-build table is the perfect solution — WEINMANN provides the technology, you build the table. This high-quality system is simple and you can put the table together quickly. With the BUILDTEQ A-300, you also have a universal tool for manufacturing timber frame wall, roof, and ceiling elements.

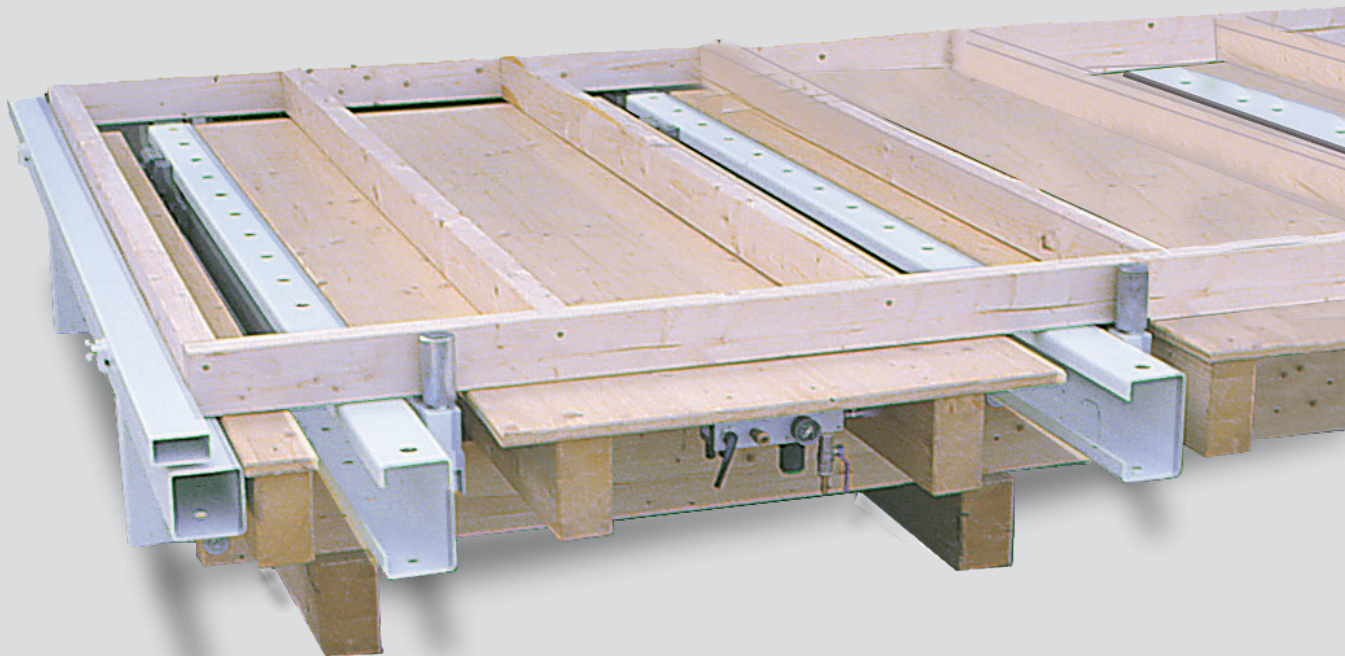

Practical application options

- Universal application for timber frame construction
- Consistent high quality is guaranteed
- Cost-effective entry-level solution due to self-assembly
- Can be expanded with modules to make a carpentry table or combined with a multifunction bridge

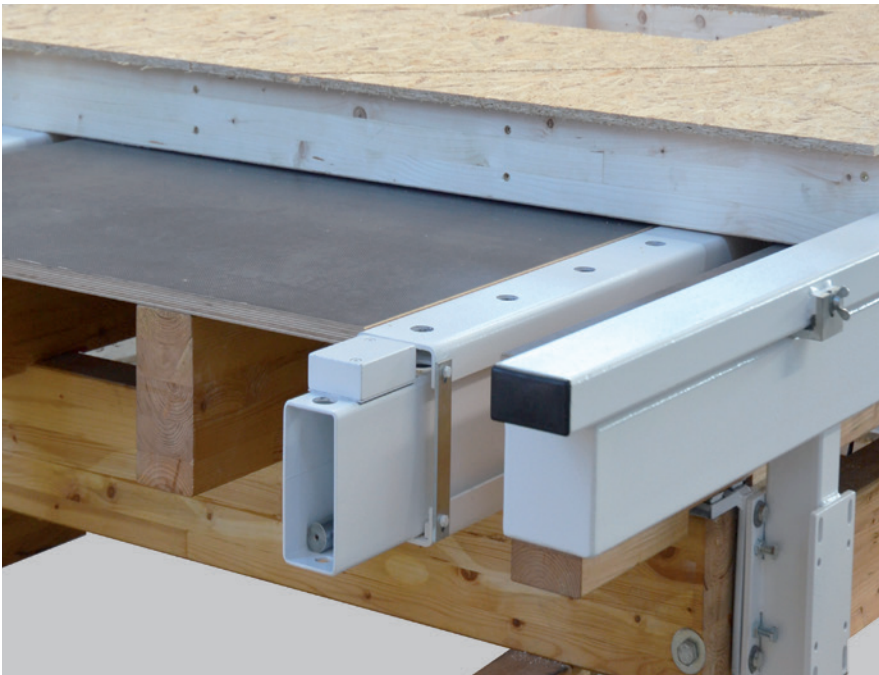

C-PowerTec clamping beams

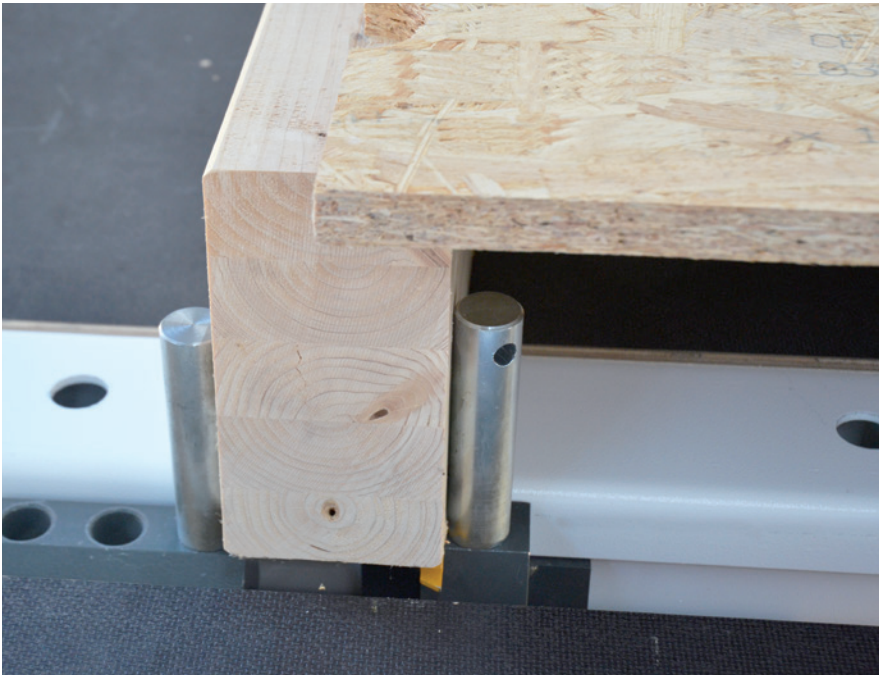

Optional: roof/ceiling clamping units

High-quality equipment

- C-PowerTec clamping beams
- Precise angled stop system
- Includes pneumatics systems for the central air supply and controlling the C-PowerTec clamping beams
- Fixtures for connecting to the table base frame
- Detailed assembly instructions



Precise angled stop system



Includes pneumatics systems for the central air supply and controlling the C-PowerTec clamping beams

BUILDTEQ A-500/A-530 carpentry tables — for universal application

These carpentry tables are ideally suited to manufacturing wall, gable, roof and ceiling elements as well as frame walls and roof dormers. The integrated technology guarantees a high level of dimensional and angular accuracy. The options available (see pages 18–19) can be used to add further equipment to the carpentry tables and thus adapt them to perfectly meet your requirements.

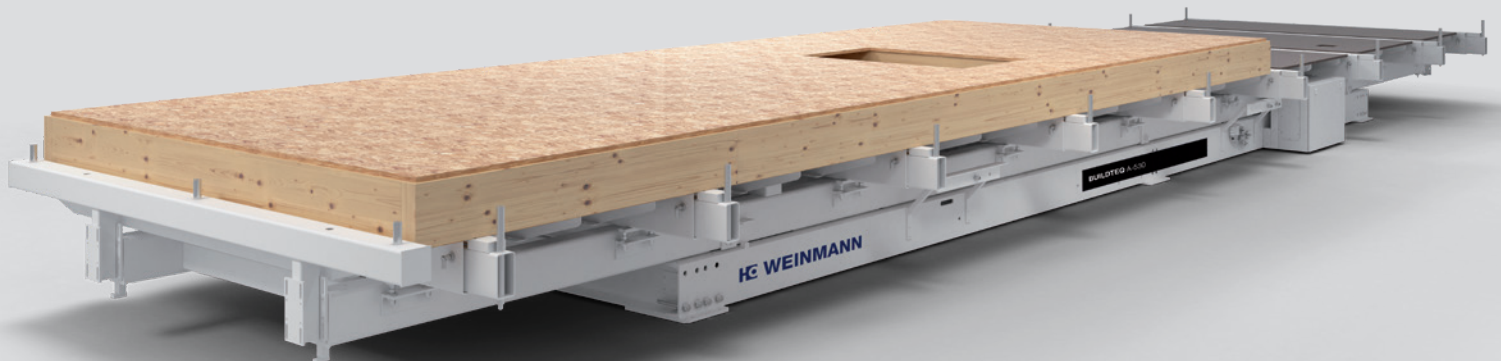

BUILDTEQ A-500
carpentry table – ideal for
timber frame construction

- Automated clamping system
- X and Y stops

BUILDTEQ A-530
carpentry table –
tilting made easy

- Integrated hydraulic
- Optional element ejector

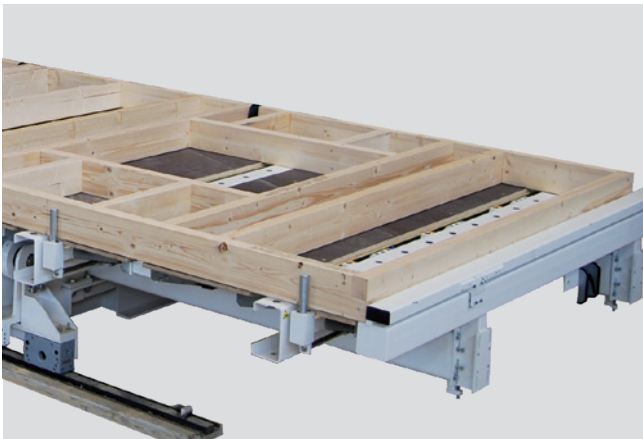

Clamping system

Enables frame works to be manufactured quickly and easily



Integrated hydraulics

Automatic tilting thanks to integrated hydraulics: The carpentry table tilts automatically to turn the elements. Using the overhead crane, the element can be picked up, turned, and put back down again.



X and Y stops

Allow for alignment at the correct angles.

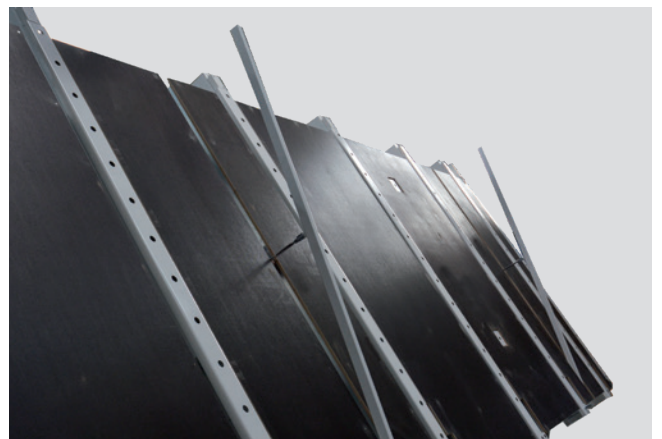

Element ejector

Optional for turning roof/ceiling elements: An integrated element ejector pneumatically pushes the element out of the clamping units during the turning operation.

BUILDTEQ A-550/A-570 carpentry tables — More options

Even with the standard features, the BUILDTEQ A-550 offers more options than other machines. Thanks to an integrated chassis and a hydraulic tilt function, this table is ideal for use as a turning table. The BUILDTEQ A-570 can be configured to meet individual requirements and is therefore ideal for specialist applications.

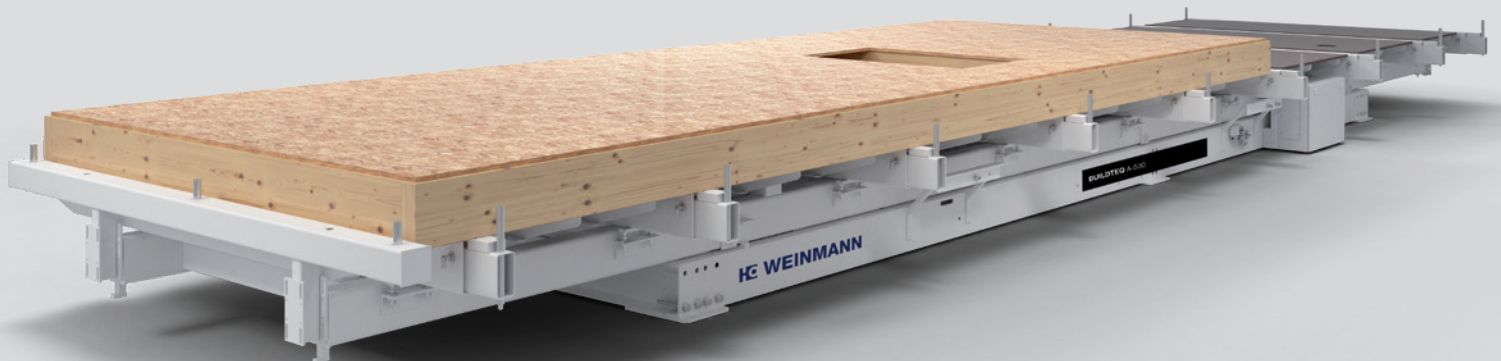

BUILDTEQ A-550 carpentry table – hydraulic system and chassis

- Hydraulic system enables automatic tilting and turning of elements
- Integrated chassis in longitudinal direction

BUILDTEQ A-570 carpentry table – individually configurable

As it can be configured to meet specific customer requirements, the BUILDTEQ A-570 offers further possibilities in addition to the equipment options (see pages 18–19):

- Integrated element ejector
- Hydraulic tilt and turning function
- Chassis available in longitudinal and transverse direction

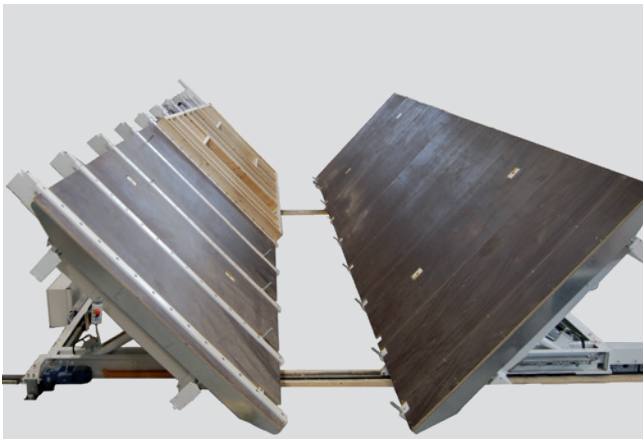

Hydraulic system

Automated tilting and turning of the elements.

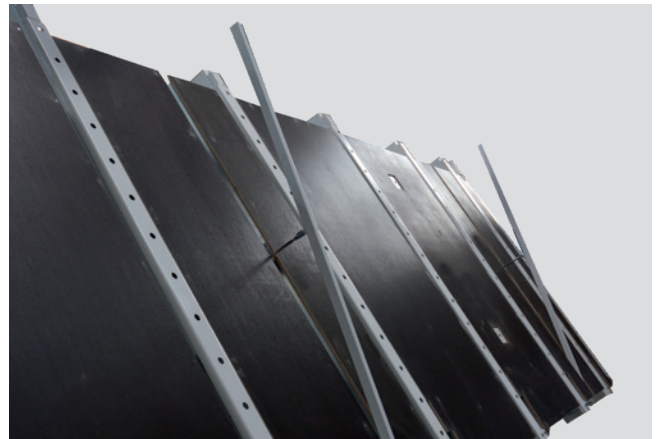

Element ejector

An integrated element ejector pneumatically pushes the element out of the clamping units during the turning operation.



Chassis in longitudinal direction

Various positioning options and element transport.

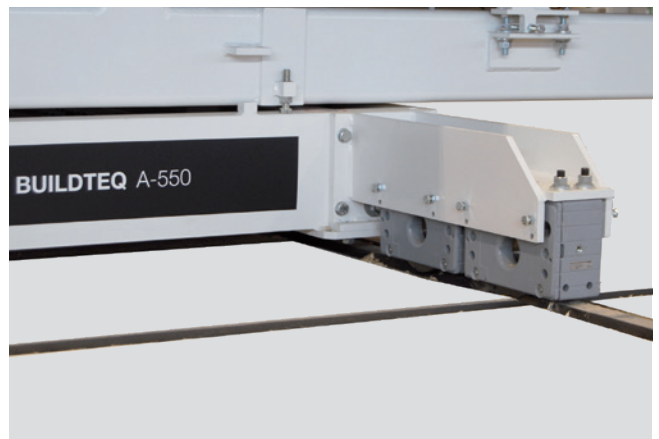

Chassis in transverse direction

Customized combinations of multiple assembly tables to make one production system.

Optional features for the BUILDTEQ series

The carpentry tables can be expanded on a modular basis using the options available. The modules can be selected individually depending on the purpose and customer requirements.

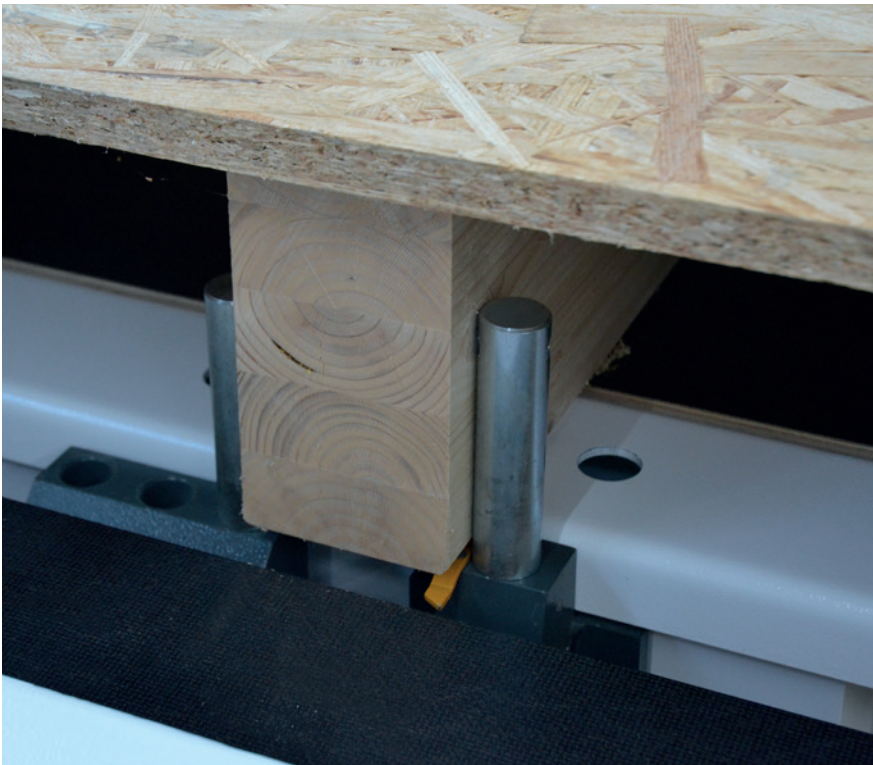

Roof/ceiling clamps

The roof rafters or ceiling beams are inserted in the opened clamps and fixed in place. When the hand lever valve is closed, the beams are aligned correctly and clamped. Even slight twists are corrected. The stop point is defined separately for each beam, allowing a high degree of dimensional accuracy to be achieved regardless of the dimensions of the individual beam.

- Each beam is clamped individually
- The clamping pairs can be fixed in place anywhere on the beam
- Precise positioning using measuring tapes and pointers
- Optional: individual roof/ceiling clamps or roof/ceiling clamp package (12 units)

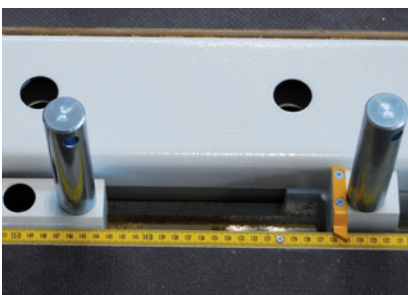

Measuring tape

Aid for better positioning of wood or clamping devices.

- Stable steel measuring tape
- Available in longitudinal or transverse direction, or even with a right-hand pitch

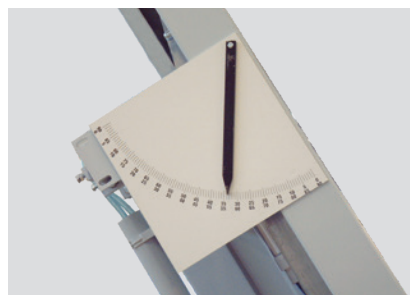

Tilt angle display

Display with division of degrees for precise adjustment of the required tilt.

- Specially suited to the manufacture of dormers
- Not suitable for BUILDTEQ A-300



Pneumatic and electrical connection options

For connecting handheld units.

- Connections are mounted on the longitudinal side of the table



Continuous X stop

Allows precise alignment of even roof and ceiling elements.

- Universal 3.2-m stop pipe
- Suitable for various applications



Universal clamps

For clamping the top and bottom plates, as well as beams, spandrels, and diagonal gable timber.

- The universal clamps can be placed anywhere on the table according to individual requirements
- Pneumatic clamping cylinders, positioned so that they can be rotated
- Rotation angle: +/- 45°



Second X stop

For simultaneous alignment of two elements.

- Work on two elements in parallel
- Two clamping circuits allow two elements to be manufactured on one assembly table. Both elements are aligned simultaneously with the second X stop.

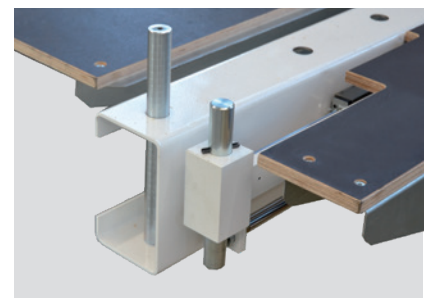

Various pin lengths, as well as height-adjustable pins

Wide variety of applications and element variants thanks to the availability of a variety pins.

- Suitable for different element thicknesses
- Stop pins for secure turning
- Stop pins for correct alignment

Butterfly turning tables — Turning in a single movement

WEINMANN butterfly turning tables offer the ideal solution for maneuvering your elements. Two assembly tables move so that when they tilt, they are opposite each other and the element is transferred from the first table (the feeder table) to the second table (the receiving table). The two assembly tables are used for the entire turning operation; no overhead crane is required. This process significantly increases the level of work safety and reduces the risk of damage to the element. The process also increases productivity as work can take place on both assembly tables in parallel.

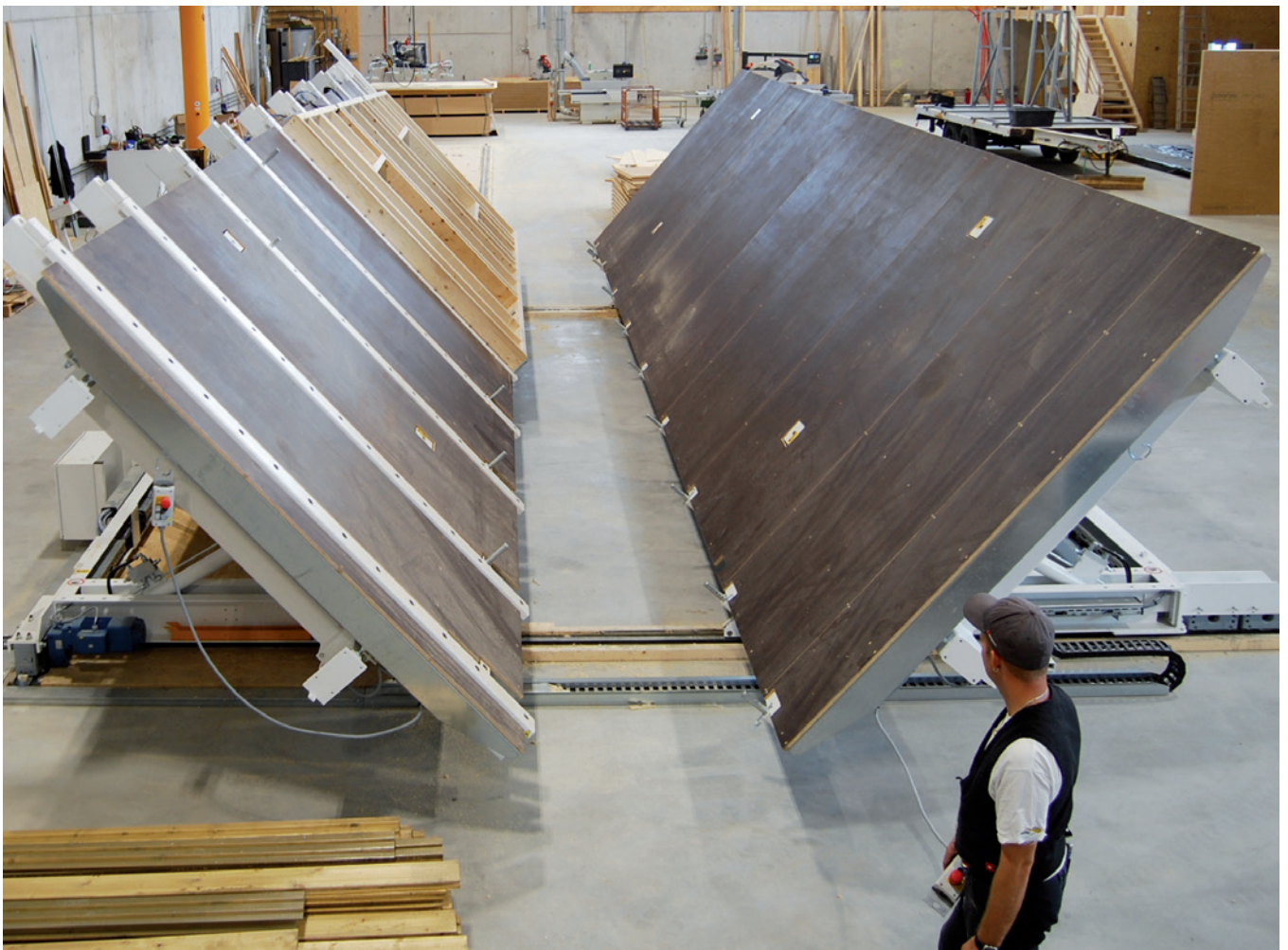

Produce closed elements easily and efficiently

The frame work is deposited on the feeder table before being clamped and nailed. The sheathing is placed on the completed frame work and secured. The hydraulic system on the tables means that the feeder table can be tilted to transfer the element to the receiving table. The receiving table also has a chassis and moves parallel to the feeder table. The receiving table tilts opposite the feeder table and takes over the element. After the turning operation, plumbing and electrical installations are installed using the receiving table and the insulation is attached. The second side of the element is then closed and secured. With just two people, a capacity of up to 30 houses per year can be achieved.

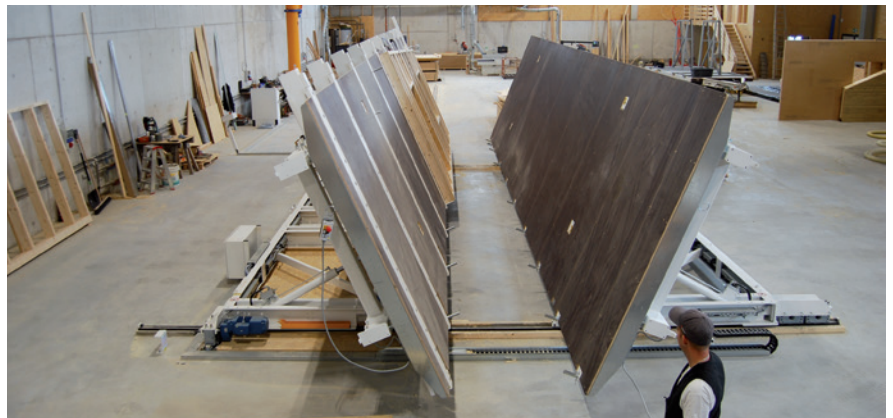
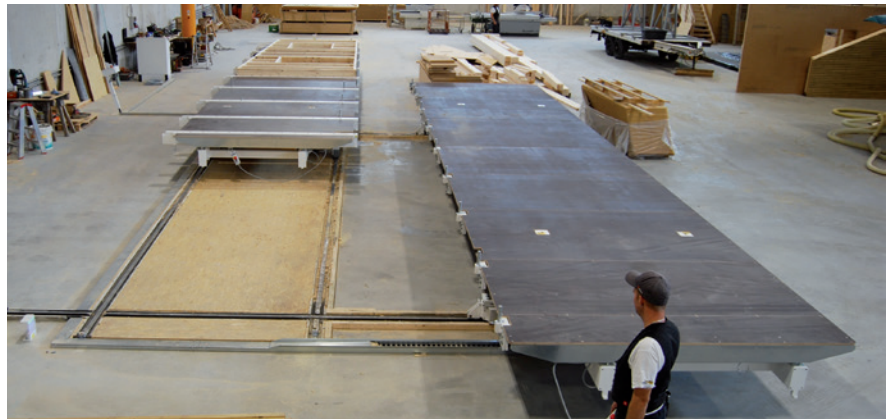

Fast and safe turning operations

- Faster turning process — within just 90 seconds
- Safe turning operations that protects the workpiece without the use of a crane
- Ergonomic work sequence thanks to short distances and optimum heights
- Simplified handling
- Optimized space

Parallel butterfly turning tables — The entry-level solution

In this system, the feeder table has a chassis in the transverse direction, allowing parallel movement into various positions. The position of the assembly table can be adjusted so that employees have enough space to work on both tables. Parallel movement also means that elements of different thicknesses can be turned. The sensors installed specify the corresponding position for the turning operation to the feeder table. The parallel butterfly turning table requires a hall space of just 12 x 7 m to manufacture 12-m elements.

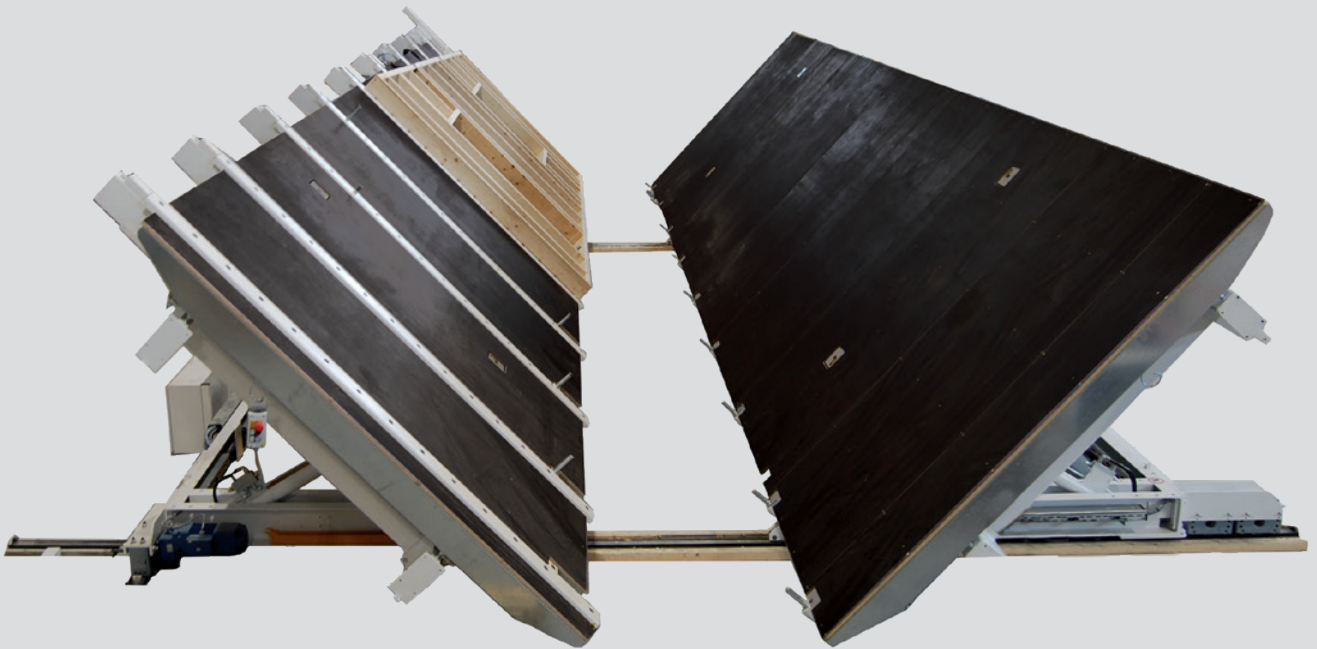

	Parallel butterfly turning table	Longitudinal/transverse butterfly turning table
	Entry-level solution	Expandable and adaptable
Hydraulic swivel device	x	x
Full-surface sheathing	x	x
Transverse chassis	x	x
Combination of longitudinal and transverse chassis	-	x
Can be expanded with a multifunction bridge	-	x
Individually configurable	-	x
Space requirement for 12 m tables	approx. 100 m ²	approx. 153 m ²

Longitudinal/transverse butterfly turning tables — Expandable and adaptable

On longitudinal/transverse butterfly turning tables, the feeder table also has a chassis in the longitudinal direction. Both assembly tables are positioned in a line and can be moved to the corresponding position as required. The feeder table moves in the longitudinal direction and the receiving table moves in the transverse direction. This system is suitable for combination with a multifunction bridge, and can therefore be expanded later to form a compact system. The defined production sequence optimizes material logistics and increases productivity.



	Parallel butterfly turning table		Longitudinal/transverse butterfly turning table	
	Feeder table	Receiving table	Feeder table	Receiving table
BUILDTEQ A-530	x			x
BUILDTEQ A-550			x	
BUILDTEQ A-570	x	x	x	x
BUILDTEQ R-530		x		
MOVETEQ R-330		x		
MOVETEQ P-700		x		x

Element tables for industrial use

The MOVETEQ element tables are truly versatile components in the production line and take over tasks such as turning elements, aligning elements at the correct angle to ensure safe sheathing and processing, transporting elements, and tilting elements for storage. The BUILDTEQ F-500 roof and ceiling table enables roof and ceiling elements in particular to be manufactured in the shortest possible time and with the highest degree of precision.



Customer-specific solutions

- Individually modifiable to suit various production situations
- Can be expanded at any time to increase capacity or the degree of automation
- Can be integrated into any production line thanks to coordinated interfaces

Efficient production processes

- High productivity thanks to automated processes
- Low-maintenance design ensures process reliability
- High levels of quality as elements can be transported without being damaged
- High cycle output thanks to short transport cycles

Versatile application options

- Automatic element alignment
- Hydraulic tilt function for installing windows, for storage or for turning
- Improved logistics thanks to individual transport systems — elements can be moved transversely and longitudinally



We can provide the right table for your requirements:

	BUILDTEQ F-500	MOVETEQ W-100	MOVETEQ P-300	MOVETEQ P-500	MOVETEQ P-700
	Specialist for roof and ceiling elements	Work and buffer station	Manual transport	Automated transport and clamping	Flexible and customizable equipment
Max. element length (m)	6 / 8 / 10 / 12	6 / 12	6 / 8 / 10 / 12		
Element width (m)	0.6 - 2.6 Option: 3.0	1.2 - 3.2 Option: 3.8			
Manual element transport	-	✓		-	optional
Automatic element transport		-		✓	optional
Pneumatic clamping of elements			✓		optional
Swivel device	optional		-		optional
Carriage	optional		-		optional
Full-surface sheathing		-	-	-	optional

BUILDTEQ F-500 roof and ceiling table — A specialist solution for roof and ceiling elements

The BUILDTEQ F-500 enables roof and ceiling elements to be manufactured quickly and easily. Using the NC-controlled clamping system, the beam positions are specified automatically based on the CAD data and the beams are clamped. If the table is integrated into a production line, the elements can also be transported, tilted, and turned. The fully automated setup process for the table is performed only during non-productive time, meaning that there is no waiting time from one element to the next. The BUILDTEQ F-500 enables correctly assembled and rectangular roof and ceiling elements to be manufactured in the shortest possible time.



Highlights

- High levels of productivity — fully automated table setup means significant time savings
- Elements have highly accurate dimensions, as the clamping systems specify the exact beam positions in combination with the NC axes
- Ideally suited for batch size 1 production: the beam layer does not have to be calibrated
- Multiple assignment possible: multiple elements can be processed on one table
- Work safely thanks to non-slip sheathing

Standard features

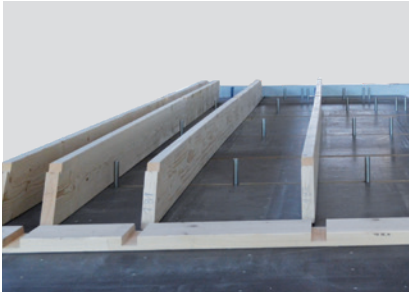

NC-controlled clamping system

Enables fully automatic clamping and alignment of beams.

- Up to six individual beams can be clamped
- Suitable for beam widths from 50–170 mm
- NC axes allow precise positioning of beams

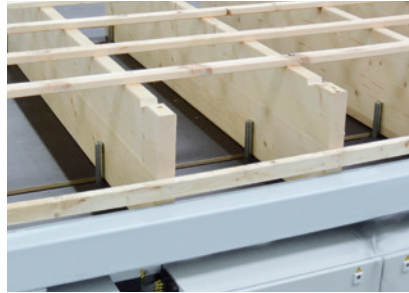

X stop

Manufacture rectangular elements with the X stop.



Clamping optimization

NC-controlled clamping system with clamping optimization

- Allows synchronous adjustment of clamping pairs to ensure the beam layer is completed in the shortest possible time

Options



Option: hydraulic tilt function

For tilting and turning elements

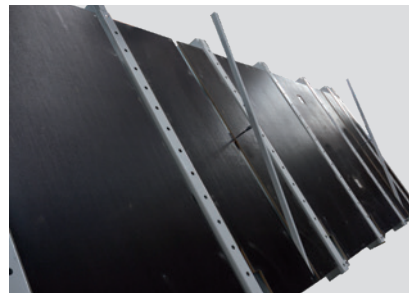

Option: integrated element ejector

The element is pneumatically pushed out of the clamping units during the turning operation.



Option: longitudinal/transverse chassis

Chassis in the longitudinal or transverse direction enable integration in a production line.

Software and control technology

wupWorks 3 software automatically converts WUP files created in a CAD program into CNC programs. The corresponding data is displayed graphically as a 3D model. The software packages wupWorks AV and wupEditor optimize the work preparation process. The woodScout diagnostic system enables systematic troubleshooting, increasing machine availability. The MMR Basic, Professional & Office software module can also be used. The BUILDTEQ F-500 is also tapio-ready.

The entire clamping system is actuated automatically using the Homatic PLC system PC23Li. The NC-controlled units clamp and position the axes and clamping pairs fully automatically.

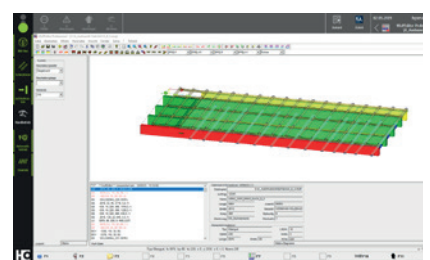

MOVETEQ P-300 element table — The entry-level solution for industrial production

The MOVETEQ P-300 element table is ideally suited for businesses entering the world of industrial production and is used for transporting, clamping and aligning elements. External and internal walls, as well as roof and ceiling elements that have been sheathed on one side, can be transported. In the longitudinal direction, elements are transported manually using roller strips.



X stop can be lowered pneumatically

Elements are aligned at the correct angle.



Option: pneumatic main clamp

The element is aligned and fixed in place so that the sheathing can be attached and secured with a multifunction bridge, for example.



Transport using roller strips

Roller strips are used for manual transport of elements in longitudinal direction.

MOVETEQ P-500 element table — Automated clamping and transportation

This element table is ideal for use as a workstation in production lines and for transporting, aligning, and clamping a wide variety of elements. With the MOVETEQ P-500, motorized hinged slat conveyors are used for longitudinal transport.

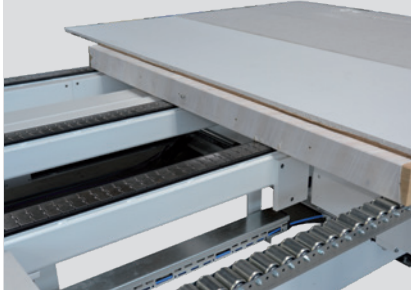

Motorized element transport

Three hinged slat conveyors and roller conveyors on the bottom plate.

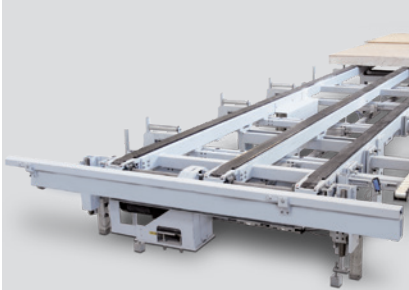

Continuous Y stop

Creation of the element at the zero edge.



Automatic element detection at the X stop

The infeed transport is slowed down, ensuring that the element is not damaged during the operation.



X stop can be lowered pneumatically

Elements are aligned at the correct angle.



Option: plaster package:

Rubber rollers, specially designed for manufacturing elements with plaster sheathing, are fitted to the infeed side of the table.



Option: pneumatic main clamp

The element is aligned and fixed in place so that the sheathing can be attached and secured.

MOVETEQ P-700 element table — Flexible, customized features

The MOVETEQ P-700 can be configured to meet individual requirements and can therefore be used flexibly for a wide range of applications. With its range of equipment options, this element table can be used with a high degree of flexibility to meet customer-specific requirements. Chassis and transport systems in the longitudinal and transverse directions mean that elements can be transported to different production lines.

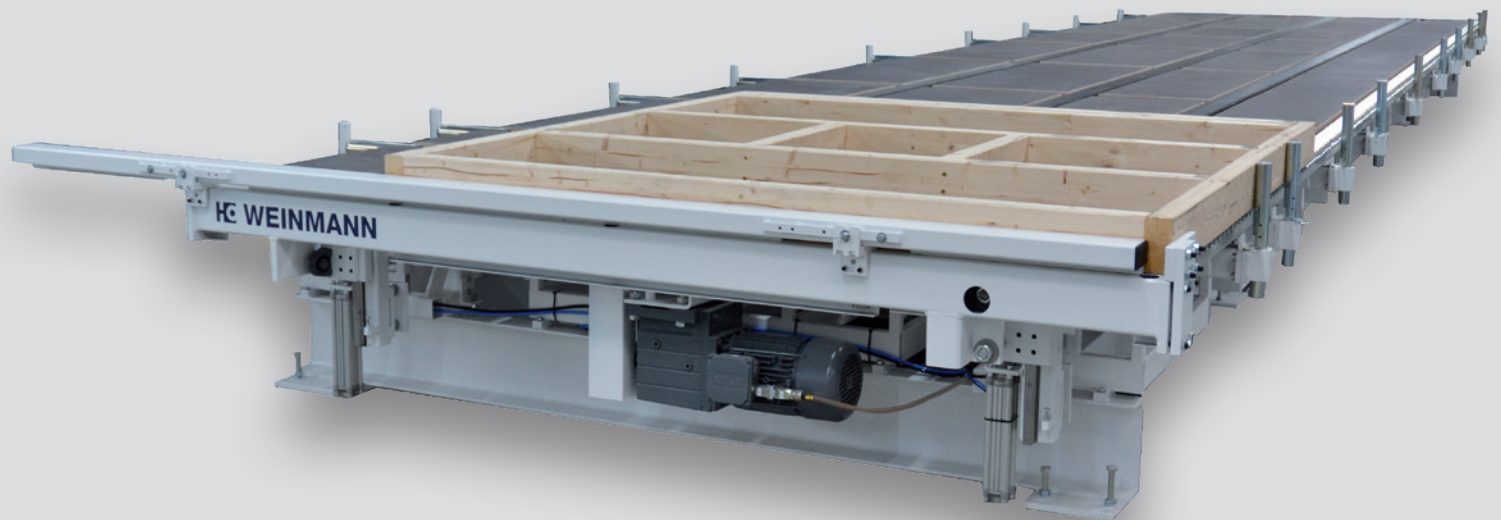

Highlights

- Individual equipment based on customer requirements
- Can be adapted and expanded at any time on a modular basis
- Integration in any production line due to adjusted interfaces
- Increased productivity because of automated processes
- Improved logistic and working process

Wide variety of features



Pneumatic clamping units

Elements can be aligned and secured automatically.

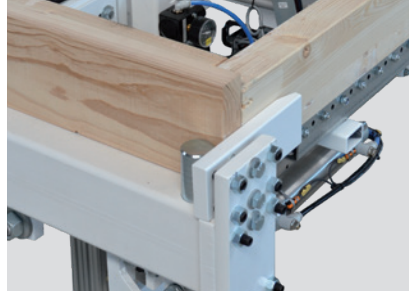

Stopper system

Elements are aligned at the correct angle.

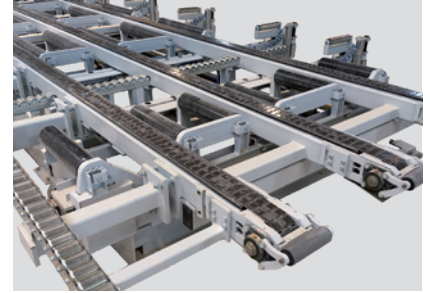

Transport systems

Elements can be transported in both the transverse and longitudinal direction.



Bottom plate clamp in Y direction

Open elements can be clamped securely regardless of the wall height. This requires no additional setup time at the table.



NC-controlled beam aligner in X direction

Ensures high precision.

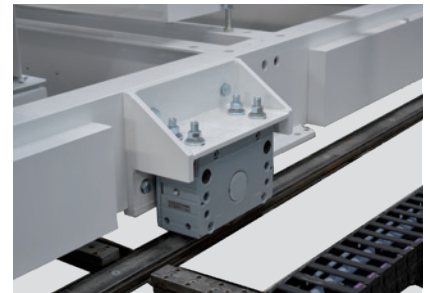

Chassis in longitudinal and transverse direction

The automated process simplifies logistics.



Clamping systems in the X direction for the first beam

Elements can be precisely aligned in the X direction.

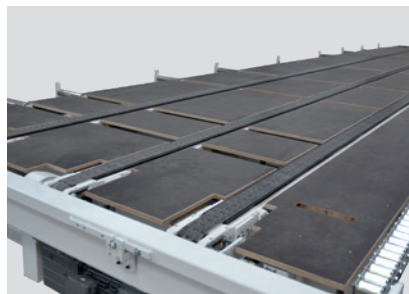

Solid, non-slip sheathing

High level of work safety thanks to a non-slip work surface.



Hydraulic tilt function

Elements can be removed and turned safely.

MOVETEQ W-100 element table — Work and buffer station

The MOVETEQ W-100 is the optimal addition to a production system and is used as a manual work and buffer station for wall elements. The elements are transported longitudinally and, depending on the equipment, aligned and clamped on the table for further processing. This element table is ideal for use in the 2x4" range, as well as for manufacturing lighter elements.

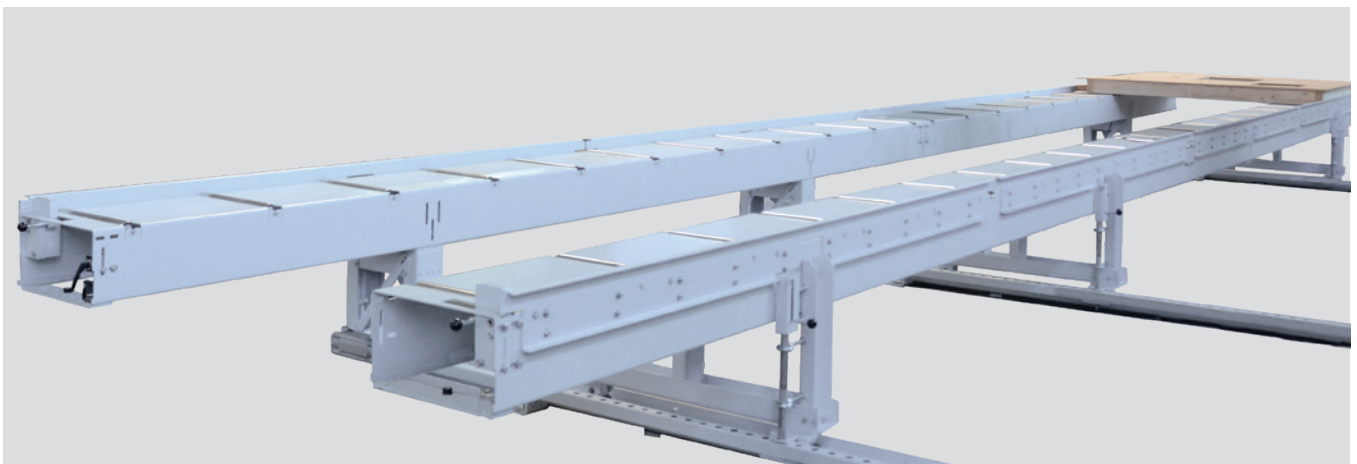

Precision guide rail

For manual width adjustment.



Integrated rollers

Ensure easy transport of elements in the longitudinal direction.

Highlights

- An open design ensures optimal accessibility for working on all elements
- Small space requirement enables easy positioning in the production hall
- Customers can perform the installation themselves



Option: lowerable stops

make it easy to align the elements.

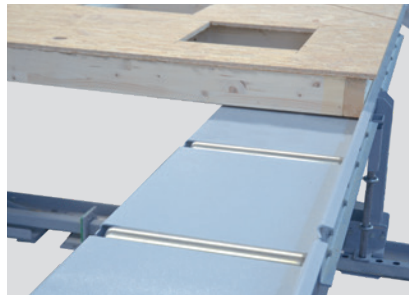

Option: continuous stops on the bottom and top plate

For manual clamping

Control technology

MOVETEQ and BUILDTEQ F-500 element tables are equipped with special control concepts which allow the clamps, stops, chassis, hydraulics as well as the turning and transport operations to be actuated automatically. When the element tables are used in production lines, they are fully interlinked.

Various operating concepts/systems



Local control panel

With complete control system



Central control panel with additional small control panels

For decentralized control of interlinked tables



Pendant control panel (attached to the table flexibly):

Control system is integrated into the table

Control system for the parallel butterfly turning table (HC014)

- A fixed control panel beneath the X stop
- Two movable pendant control panels on the tables for the turning operation

Control system for the longitudinal/transverse butterfly turning table (HC014)

- Fixed control panel with a view of the tables
- Additional decentralized control panel for controlling the travel functions
- Two movable pendant control panels on the tables for the turning operation

Control system for production lines (HC014)

- For production lines with a maximum of six element tables
- Different control groups are possible
- All standard functions such as clamp, stop, chassis, hydraulics, turning and transport can be controlled
- A small number of diagnostic options are available: remote service via CNC-machine

Highlights

- All machines are interlinked, which simplifies operation
- The safety systems are also interlinked, ensuring an extremely safe working environment
- Control of the turning and travel functions
- The function sequences are automated, and all functions can also be controlled individually

Control system for production lines (PC23Li)

- For production lines with a maximum of six element tables and complex requirements
- Different control groups are possible
- Option to connect data records
- All standard functions such as clamp, stop, chassis, hydraulics, turning and transport can be controlled
- Extended diagnostic options: own remote diagnostics
- tapio-ready



With the wupWorks 3 software

the CAD-data can be fully automatically modified in CNC-programs.

Technical data for carpentry tables

TABLE DIMENSIONS	BUILDTEQ A-300	BUILDTEQ A-500	BUILDTEQ A-530	BUILDTEQ A-550	BUILDTEQ A-570
1 Length (m)	7 / 8.3 / 10 / 11.8		6.2 / 10.2 / 12.2		
2 Width (m)			3		
3 Processing height (m)	customer-specific		0.7		
Clamping range (m)			0.4 - 3.8		
Sheathed clamping range (m)			0.4 - 2.6		
Approx. weight (t)	0.6 / 0.7 / 0.8 / 1		5 / 6 / 6.5		

PRODUCT DIMENSIONS	BUILDTEQ A-300	BUILDTEQ A-500	BUILDTEQ A-530	BUILDTEQ A-550	BUILDTEQ A-570
Min. element length (m)	variabel		2		
Max. element length (m)	7 / 8 / 10 / 12		6 / 8 / 10 / 12		
Min. element width (m)			0.4		
Max. element width (m)			3.8		
Max. element weight (t)			3.5		

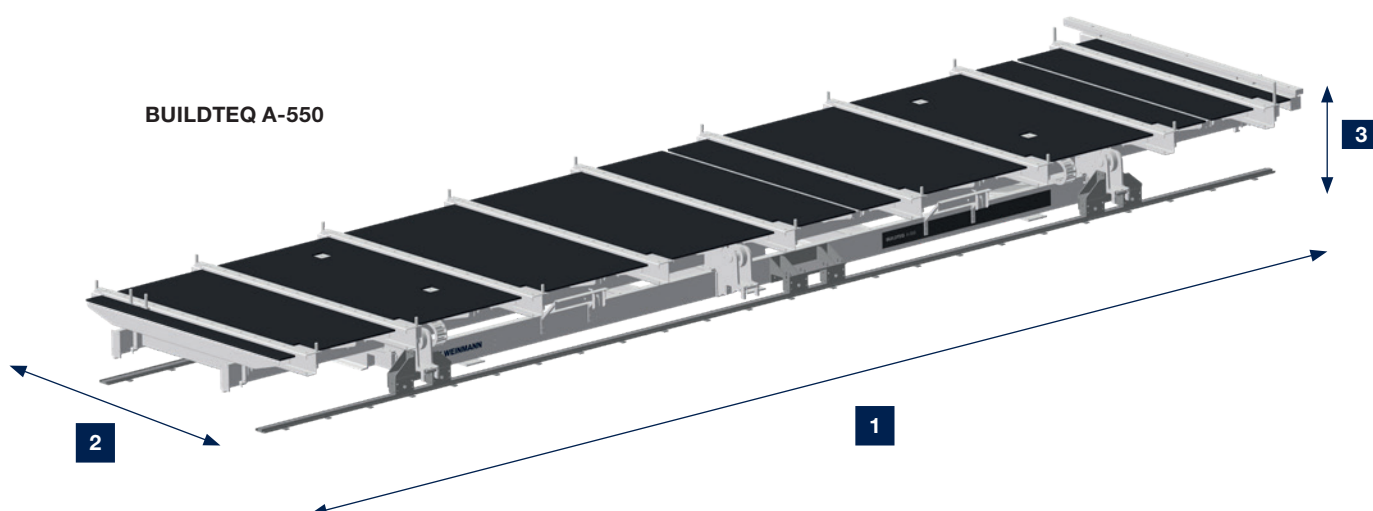

Technical data for element tables

TABLE DIMENSIONS	BUILDTEQ F-500	MOVETEQ W-100	MOVETEQ P-300	MOVETEQ P-500	MOVETEQ P-700
1 Length (m)	6.2 / 8.2 / 10.2 / 12.2	6.1 / 12.1	6.2 / 8.2 / 10.2 / 12.2		
2 Width (m)	3	3.6	3.4		
3 Processing height (m)	0.7				
Clamping range (m)	0.6 - 2.6 Option up to 3	1.6 - 3.2 Option up to 3.8	1.2 - 3.2 Option up to 3.8		
Sheathed clamping range (m)	up to 3	-	-	-	Optional
Approx. weight (t)	5.5 / 6 / 6.5 / 7	1.4 / 2.8	1 / 1.5 / 2 / 2.5	1.5 / 2 / 2.5 / 3	5 / 5.5 / 6 / 6.5

PRODUCT DIMENSIONS	BUILDTEQ F-500	MOVETEQ W-100	MOVETEQ P-300	MOVETEQ P-500	MOVETEQ P-700
Min. element length (m)	2				
Max. element length (m)	6 / 8 / 10 / 12				
Min. element width (m)	0.6	1.6	1.2		
Max. element width (m)	3	3.2	3.2 Option up to 3.8		
Max. element weight (t)	3.5	1.5	3.5		

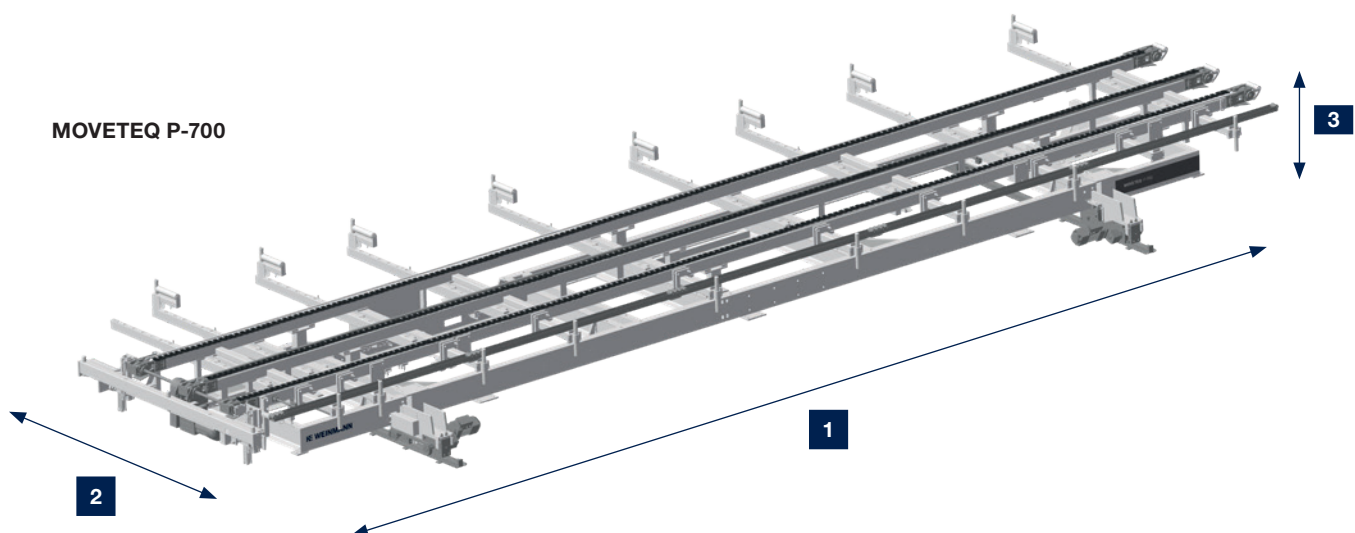

Configuration options

The choice is yours. The options available provide a wide range of options for adapting your assembly tables to your production requirements. The table below contains an overview of the options that are available for the respective machine types.

	BUILDTEQ A-300	BUILDTEQ A-500	BUILDTEQ A-530	BUILDTEQ A-550
Number of clamping cylinders (unit)	4 / 5 / 6 / 7	5 / 8 / 9	5 / 8 / 9	5 / 8 / 9
Clamping force per cylinder, pneumatic (N)	750	750	750	750
X stop	✓	✓	✓	✓
X stop as continuous pipe	Option	Option	Option	Option
Second X stop with pin	Option	Option	Option	Option
Retractable X stop				
Sheathing	customer-specific	✓	✓	✓
Tilt function (hydraulics)		Option	✓	✓
Chassis (longitudinal/transverse)				✓
2 clamping circuits	✓	✓	✓	✓
Roof/ceiling clamps	Option	Option	Option	Option
Pneumatic universal clamp	Option	Option	Option	Option
Additional C-PowerTec tie beams	Option			
Pneumatic main clamp				
Beam aligner in X direction				
Bottom plate clamp				
Transport systems that can be raised (longitudinal/transverse)				
Longitudinal transport via roller strips				
Longitudinal transport via hinged slat conveyor				
Tilt display			Option	Option



BUILDTEQ A-570	BUILDTEQ F-500	MOVETEQ W-100	MOVETEQ P-300	MOVETEQ P-500	MOVETEQ P-700
5 / 8 / 9	18 / 24		6 / 7 / 8 / 9	6 / 7 / 8 / 9	6 / 7 / 8 / 9
750			750	750	750
✓	✓	✓	✓	✓	
Option	✓	Option	Option	Option	Option
Option					
		✓	✓	✓	Option
✓	✓				Option
Option	Option				Option
Option	Option				Option
✓	✓				
Option					
Option					
Option					
Option			Option	Option	
					Option
					Option
					Option
		✓	✓		Option
				✓	Option
Option					

HC LIFE CYCLE SERVICES

Optimal service and individual consultations are included in the purchase of our machines. We support you with service innovations and products which are especially tailored to your requirements. With short response times and fast

customer solutions we guarantee consistently high availability and economical production – over the entire life cycle of your machine.



REMOTE SERVICE

- Hotline support via remote diagnosis by our trained experts regarding control, mechanics and process technology. Thus, more than 90% less on-site service required and consequently a faster solution for you!
- The ServiceBoard App helps to solve tasks in a fast, simple and concrete way. This is achieved by mobile live video diagnosis, automatic sending of service requests or the online spare parts catalog eParts.

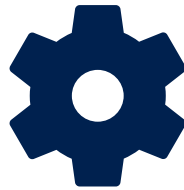

SPARE PARTS SERVICE

- High spare parts availability and fast delivery.
- Ensuring quality by predefined spare parts and wear parts kits, comprising original spare parts.
- Identify and inquire for spare parts online under www.eParts.de 24/7, or buy even faster and more comfortably in the new HOMAG Webshop eCommerce.



MODERNIZATION

- Keep your machinery up to date and increase your productivity as well as your product quality, This is how you can meet tomorrow's requirements today!
- We support you with upgrades, modernization as well as individual consultancy and developments.



DIGITAL SERVICES

- ISN (intelliServiceNet) – The new remote service solution of the future! Fast restart of production because the remote service employee has extensive access to relevant physical data.
- intelliAdvice App – provides help for self-help. The preventive solutions proposed in the new App are the combination of our experiences and existing machine data.



SOFTWARE

- Telephone support and consultancy through software support.
- Subsequent networking of your machinery with intelligent software solutions ranging from construction to production.



FIELD SERVICE

- Increased machine availability and product quality by certified service staff.
- Regular checks through maintenance / inspection guarantee the highest quality of your products.
- We offer you the highest availability of technicians in order to reduce downtimes in case of unpredictable troubles.

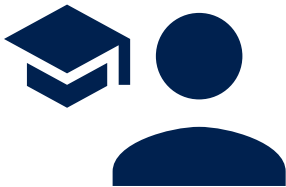

TRAINING

- Thanks to training perfectly suited to your requirements, your machine operators can optimally operate and maintain the WEINMANN machines.
- The training also include customer-specific training documents with exercises proven in practice.
- Online training and webinars. Learn without traveling, meet your trainer in the digital classroom.

For you more than...

1,350

service employees worldwide

90%

less on-site service thanks to successful remote diagnosis

5,000

customer training sessions per / year

150,000

machines, all electronically documented in 28 different languages – in eParts

WEINMANN Holzbausystemtechnik GmbH

info@weinmann-partner.de
www.homag.com/weinmann

YOUR SOLUTION

